



*Designs of distinction*<sup>®</sup>  
Kitchen, Bath & Home  
by BWI



@designsofdistinction\_kbh  
[www.brownwoodinc.com](http://www.brownwoodinc.com)

Decorative American-Made wood,  
materials and metal components for  
kitchen, bath and home.

# TABLE OF CONTENTS



7040 NORTH LAWNSDALE AVE.  
LINCOLNWOOD, IL 60712

(p) 800.328.5858

(f) 815.425.8777

[www.brownwoodinc.com](http://www.brownwoodinc.com)

[info@brownwoodinc.com](mailto:info@brownwoodinc.com)



[www.facebook.com/  
designsofdistinction\\_kbh](http://www.facebook.com/designsofdistinction_kbh)



[www.linkedin.com/company/  
designsofdistinction](http://www.linkedin.com/company/designsofdistinction)



[www.instagram.com/  
designsofdistinction\\_kbh](http://www.instagram.com/designsofdistinction_kbh)

©BROWN WOOD INC.  
ALL RIGHTS RESERVED 2023  
ALL DESIGNS ARE THE EXCLUSIVE PROPERTY OF  
BROWN WOOD, INC. AND MAY NOT BE USED OR  
REPRODUCED WITHOUT EXPRESS  
WRITTEN PERMISSION



RESPONSIBLE  
STEWARDS OF THE  
ENVIRONMENT

## CATALOG BY PRODUCT

### INTRODUCTION

- 1 MATERIALS & FINISHES
- 2 HOW TO READ OUR CATALOG
- 4 SPECIAL CUTS & SERVICES

### 6 MATERIALS

- 7 TAMBOUR
- 11 METAL ACCENT TRIM
- 14 CUT-TO-SIZE MATERIALS

### 19 POSTS, COLUMNS & TABLE LEGS

### 38 END PANELS & METAL BASES

### 42 BUN FEET

### 52 BRACKETS & CORBELS

### 65 CREATE-A-COLUMN™ & HALF ROUND MOULDINGS

### 68 SHELVING

### 75 DECORATIVE MOULDINGS & TILES

### 81 FINISHING TOUCHES &

### HARDWARE COMPONENTS

### 81 GALLERY RAIL

### 83 OUTLET COVERS & FLOOR VENTS

### 88 BISTRO SHELVING

### 90 WARRANTY INFORMATION & INDEX

## DOWNLOAD OUR DESIGN CATALOGS:



ProKitchen  
Professional Design Software

cabinet vision



3D Warehouse

2020

Chief Architect®

## PROUD MEMBERS OF:



Wood Products  
Manufacturers  
ASSOCIATION



**SOLID BRASS FEET AND SLIPPER CUPS**

Our new line of Solid Brass Feet & Slipper Cups feature the finest quality cast brass. Cast brass, made of a copper/zinc alloy, is known for its material integrity, smooth surface finish, durability, and strength. Cast brass Feet & Slipper Cups will outlast normal wear and will maintain its bright finish for years to come.



**AB:** Antique Brass



**WR:** Flat Black



**PB:** Polished Brass



**CR:** Chrome



**SB:** Satin Brass

**ANODIZED ALUMINUM FERRULES, SLEEVES AND METALLIC TRIM**

We use a special Aluminum alloy to create our ferrules, metallic trim, and other decorative aluminum accents. This special alloy can be chemically brightened. Our Aluminum finishes are anodized and feature bright chromes, soft satins and deep matte finishes. Anodizing is considered the best method of finishing in order to achieve a true metallic look. Anodized finishes are extremely durable and will not flake, peel or fade. **If exact color is critical to your project, please request color samples.**

**Sample Kits available on our website.**



Sample Kits Available Here.  
<http://qr.brownwoodinc.com/SampleKits>

WOOD SPECIES

We source only the finest FAS hardwoods for our products. The majority of our products are made from laminated blocks with more than one glue line. We strive to provide the best possible color match between staves, but variations may occur. Variations in color and grain pattern are natural characteristics of wood and are not considered defects.

**HM:** Hard Maple    **AK:** Red Oak    **AL:** Alder    **CH:** Cherry    **WK:** White Oak    **HK:** Hickory    **WL:** Walnut



POWDER COATED STEEL AND METALS

Our steel products are laser cut, Tig welded by skilled craftsmen, and powder coated in a non-toxic, environmentally safe finish. Because powder coating is baked onto the steel, the finish is substantially harder than a wet paint finish. The results provide a finished part that is resistant to scratching, chipping, and peeling and can handle extreme weather conditions with minimal corrosion. In addition, powder coating is environmentally friendly, is non-toxic, emits no harmful fumes, and the powder can be recycled.

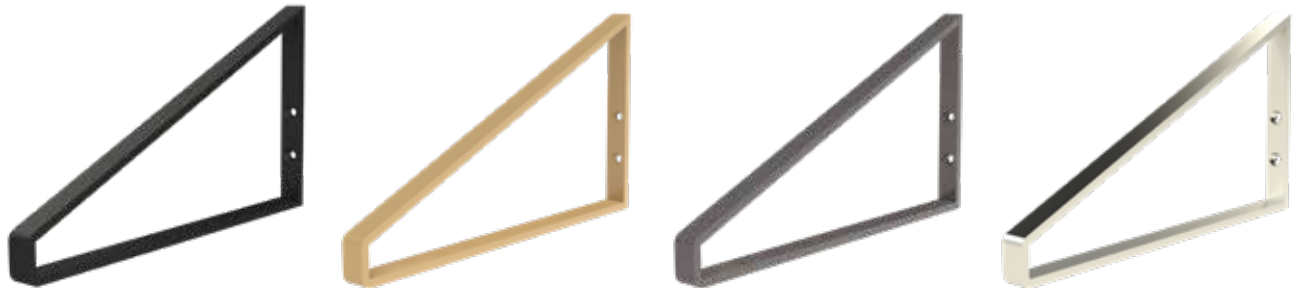

**WR:** Flat Black    **GL:** Gold    **GR:** Gun Metal Grey    **SS:** Stainless Steel

See website for available species and metal finishes by product. New species/finishes are added regularly. Our website is the most up-to-date resource for current styles, materials and finishes.

[www.brownwoodinc.com/dod](http://www.brownwoodinc.com/dod)

Don't forget, custom manufacturing is our specialty. If you don't see what you need, give us a call or submit a request for quote from our website.



Scan For Contact Info.  
<https://www.brownwoodinc.com/dod/contact-us/>



### ELECTROPLATED WIRE GRILLE FINISHES

Our electroplated Decorative Grilles are hand woven & crimped from superior steel wire. The process of electroplating deposits metal finishes onto the steel through electricity creating both bright and antique finishes. Finishes can vary from run to run. **If exact color is critical to your project, please request samples.**

**Sample Kits available on our website.**



**SS:** Stainless Steel Look



**SN:** Polished Satin Nickel

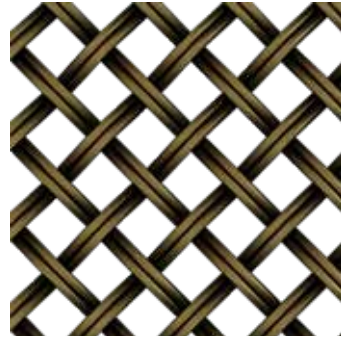

**AB:** Antique Brass

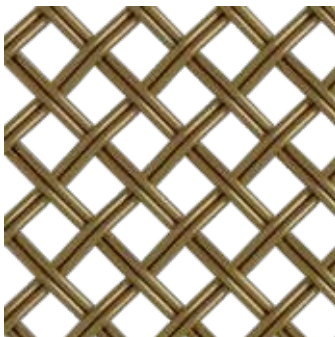

**SB:** Satin Brass

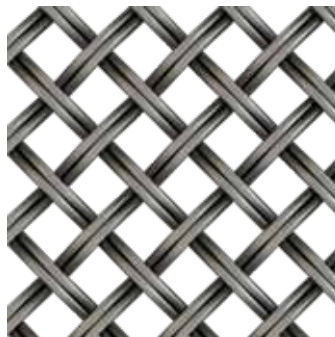

**AP:** Antique Pewter



**WR:** Flat Black

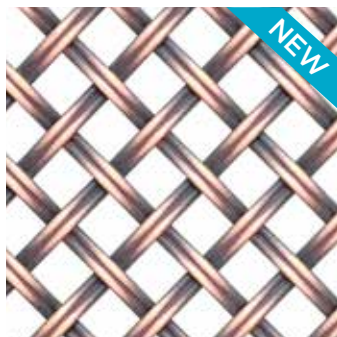

**AC:** Antique Copper



Cut-To-Size Order Forms Available Here.  
<http://qr.brownwoodinc.com/CTSOrderForm>

HOW TO READ OUR CATALOG

This catalog is organized by product category.  
 Products are grouped by style with available sizes and species.

**MISSION CORBEL** ← Product Name



**01601206-1** ← Item SKU. The dash (-) is a placeholder for the material you choose. See price list for all available materials.

2.75" W x 2.625" D

**01601205-1**

5.75" W x 3.875" D

**01601204-1**

3.5" W x 3.5" D x

**01601203-1**

3.5" W x 9" D x 13" L

Available Sizes

**Corbels & Brackets**



**01904993-1**

3.75" W x 8.5" D x 13" L

**Vertical Mouldings**



**01961520-2**

.75" W x .34375" T x 96" L

**Posts & Columns**  
 SQ. or Diameter

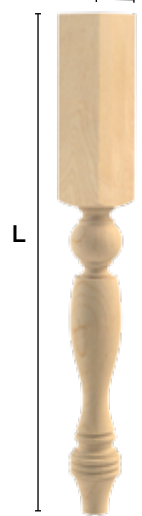

**01060210-1**

3.75" SQ. x 35.25" H

**Bun Foot**

SQ. or Diameter



**01704110-1**

3" DIAM. x 6.125" H

**Create-A-Column® Components**



**01391510-2**

2" W x .906" D x 9.4375" L

**Horizontal Mouldings**

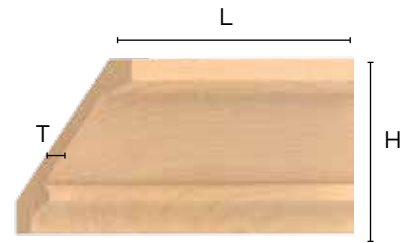

**01807000-1**

4.25" H x .625" T x 96" L

**Tiles**

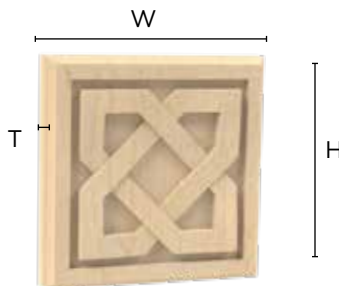

**01902025-1**

2.875" SQ. x .5" T

**SPECIAL WOOD CUTS & SECONDARY SERVICES**

We are pleased to offer several options to help you in your design process. Secondary services such as splitting in half, quarter notching, electrical outlet notching, and hanger bolt installation are available on the majority of our columns, legs and bun feet. Additional charges apply.

**QUARTER CUT**



**01QUARTERNOTCH**

Quarter notching creates a single quartered piece and a single 3/4 piece. Both pieces are included in purchase.

**SPLIT**



**01SPLITCOLUMN**

Split column in half. 1/8" of thickness may be lost due to saw kerf. Both halves are included in purchase.

**ANGLE CUT**



**01ANGLECUT**

Product is cut at an angle from corner to corner, full length only. Both pieces are included in purchase.

**STOP NOTCH**



**01STOPNOTCH**

Stop notch a column. Let us know how far down you would like notched.

**SPLIT BUN FOOT**



**01SPLITFEET**

Split bun foot in half. Both pieces are included in purchase.

**HANGER BOLT**



**01HANGERBOLT**

5/16-18 hanger bolt installed in one end. Hanger bolt installed to protrude 1/2".

**BOX ROUTE**



**01BXROUTE**

Add an electrical box to your column.

**ELECTRICAL BORE**



**01ELECBORE**

A 1/2" hole the entire length of the column.

**MOULDING & TAMBOUR TRIM**

We will cut your 96" moulding to 92" to reduce shipping costs.

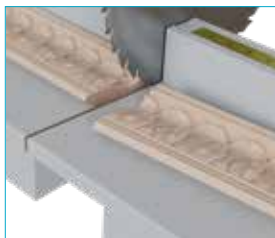

Scan for order forms.  
<http://qr.brownwoodinc.com/OrderForms>

\*Please note - not all items can be cut in all the formats above, nor can all columns receive an Electrical Box Notch. Please review the product on our website to determine which operations are available or contact customer service at 1-800-328-5858 or [orders@brownwoodinc.com](mailto:orders@brownwoodinc.com) for more information.







[www.brownwoodinc.com/dod](http://www.brownwoodinc.com/dod)

**All custom cut products are non-returnable.**









### Available Species and Finishes







#### Electroplated Wire Grille Finishes

-  **AB:** Antique Brass
-  **AC:** Antique Copper
-  **AP:** Antique Pewter
-  **SB:** Satin Brass
-  **SN:** Polished Satin Nickel
-  **SS:** Stainless Steel Look
-  **WR:** Flat Black

#### Anodized Aluminum Finishes

-  **BA:** Brushed Aluminum
-  **CR:** Chrome
-  **PB:** Polished Brass
-  **SB:** Satin Brass
-  **ST:** Satin Stainless
-  **WB:** Warm Bronze
-  **WR:** Flat Black

#### Wood Species

-  **AK:** Red Oak
-  **AL:** Alder
-  **CH:** Cherry
-  **HM:** Hard Maple
-  **PT:** Paint Grade
-  **WK:** White Oak
-  **WL:** Walnut



LARGE PROFILE FLEXIBLE TAMBOUR

All flexible tambour is available in **Red Oak (AK)**, **Hard Maple (HM)**, **Paint Grade Poplar (PT)**, **Walnut (WL)** & **White Oak (WK)**.

**STYLE 203**  
 1" BEVEL FLEXIBLE TAMBOUR - .313" THICK

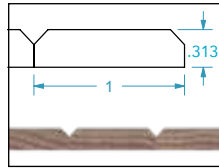

**011248203-1**  
 12"W X .313"T X 48"L  
**011296203-1**  
 12"W X .313"T X 96"L

**STYLE 204**  
 1" BEVEL FLEXIBLE TAMBOUR - .5" THICK

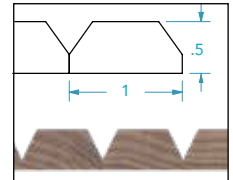

**011248204-1**  
 12"W X .5"T X 48"L  
**011296204-1**  
 12"W X .5"T X 96"L

**STYLE 105**  
 1/2" BEAD FLEXIBLE TAMBOUR - .375" THICK

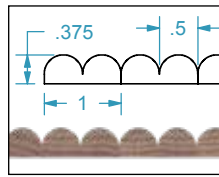

**011248105-1**  
 12"W X .375"T X 48"L  
**011296105-1**  
 12"W X .375"T X 96"L

**STYLE 104**  
 1" BEAD FLEXIBLE TAMBOUR - .5" THICK

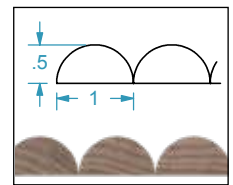

**011248104-1**  
 12"W X .5"T X 48"L  
**011296104-1**  
 12"W X .5"T X 96"L

**STYLE 207**  
 1-1/2" BEVEL FLEXIBLE TAMBOUR- .75" THICK

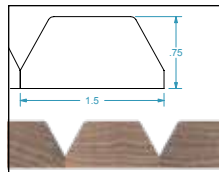

**011248207-1**  
 12"W X .75"T X 48"L  
**011296207-1**  
 12"W X .75"T X 96"L

**STYLE 206**  
 1-1/2" BEVEL FLEXIBLE TAMBOUR- .344" THICK

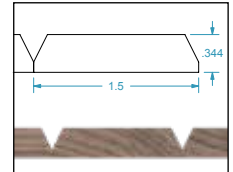
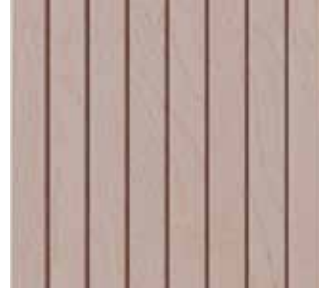

**011248206-1**  
 12"W X .344"T X 48"L  
**011296206-1**  
 12"W X .344"T X 96"L

**STYLE 106**  
 1.5" BEAD FLEXIBLE TAMBOUR - .75" THICK

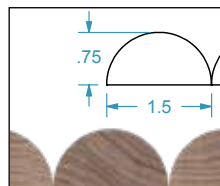

**011248106-1**  
 12"W X .75"T X 48"L  
**011296106-1**  
 12"W X .75"T X 96"L



Tambour Sample Kits available.  
<http://qr.brownwoodinc.com/TambourSampleKits>

**FLEXIBLE TAMBOUR PROFILES**

All flexible tambour is available in **Red Oak (AK)**, **Hard Maple (HM)**, **Paint Grade Poplar (PT)**, **Walnut (WL)** & **White Oak (WK)**.

**STYLE 103**  
**3/16" BEAD FLEXIBLE TAMBOUR - .313" THICK**

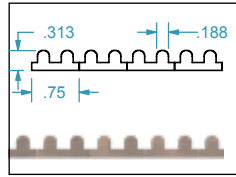

**011248103-1**  
 12"W X .313"T X 48"L  
**011296103-1**  
 12"W X .313"T X 96"L

**STYLE 101**  
**3/4" BEAD FLEXIBLE TAMBOUR - .313" THICK**

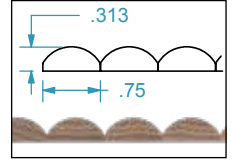

**011248101-1**  
 12"W X .313"T X 48"L  
**011296101-1**  
 12"W X .313"T X 96"L

**STYLE 202**  
**3/4" BEVEL FLEXIBLE TAMBOUR -.344" THICK**

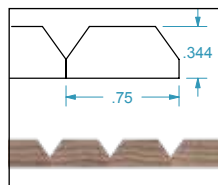

**011248202-1**  
 12"W X .344"T X 48"L  
**011296202-1**  
 12"W X .344"T X 96"L

**STYLE 201**  
**3/4" BEVEL FLEXIBLE TAMBOUR - .313" THICK**

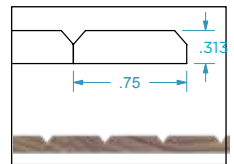

**011248201-1**  
 12"W X .313"T X 48"L  
**011296201-1**  
 12"W X .313"T X 96"L

Tambour Sample Kits available on our website.



Featured: Painted/Stained American Hardwood Tambour

**FLEXIBLE AND SOLID PANEL TAMBOUR**

Tambour Sample Kits available on our website. Solid Tambour available in Alder (AL), Cherry (CH), Hard Maple (HM), Red Oak (AK), Paint Grade Maple (PT), Walnut (WL), and White Oak (WK).

AK, HM, PT, WK, WL

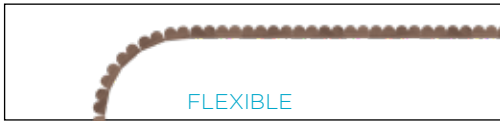

**1/4" BEAD FLEXIBLE TAMBOUR**  
.25" T

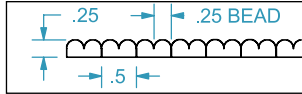

- 011248100-1** 12"W x 48"L x .25"T
- 011296100-1** 12"W x 96"L x .25"T
- 012448100-1** 24"W x 48"L x .25"T

STYLE 100

AK, AL, CH, HM, PT, WK, WL



**1/4" BEAD SOLID TAMBOUR**  
PANEL - .25" T

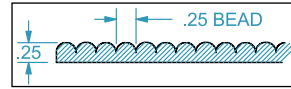

- 012446100-1** 24"W x 46"L x .25"T

**3/8" BEAD FLEXIBLE TAMBOUR**  
.375" T

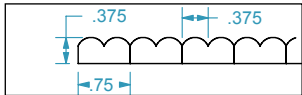

- 011248107-1** 12"W x 48"L x .375"T
- 011296107-1** 12"W x 96"L x .375"T
- 012448107-1** 24"W x 48"L x .375"T

STYLE 107

**3/8" BEAD SOLID TAMBOUR**  
PANEL - .375" T

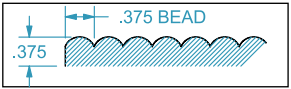

- 012446107-1** 24"W x 46"L x .375"T

AK, HM, PT, WK, WL

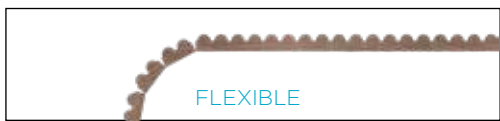

**.29" BEAD FLEXIBLE TAMBOUR**  
.375" T

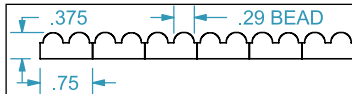

- 011248102-1** 12"W x 48"L x .375"T
- 011296102-1** 12"W x 96"L x .375"T
- 012448102-1** 24"W x 48"L x .375"T

STYLE 102

AK, AL, CH, HM, PT, WK, WL



**.29" BEAD SOLID TAMBOUR**  
PANEL - .375" T

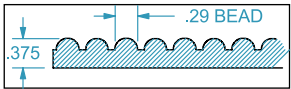

- 012446102-1** 24"W x 46"L x .375"T

**.29" BEAD FLEXIBLE TAMBOUR**  
.25" T

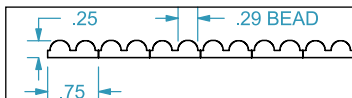

- 011248110-1** 12"W x 48"L x .25"T
- 011296110-1** 12"W x 96"L x .25"T
- 012448110-1** 24"W x 48"L x .25"T

STYLE 110

**.29" BEAD SOLID TAMBOUR**  
PANEL - .25" T

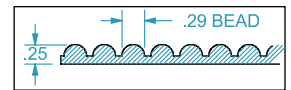

- 012446110-1** 24"W x 46"L x .25"T



Tambour Sample Kits available on our website.

AK, HM, PT, WK, WL



FLEXIBLE

**.25" COVE-CUT FLEXIBLE TAMBOUR - .25" T**

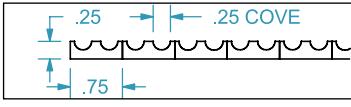

STYLE 402

**011248402-1** 12"W x 48"L x .25"T  
**011296402-1** 12"W x 96"L x .25"T  
**012448402-1** 24"W x 48"L x .25"T

AK, AL, CH, HM, PT, WK, WL



SOLID PANEL

**.25" COVE-CUT SOLID TAMBOUR PANEL - .25" T**

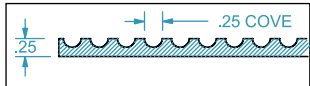

**012446402-1** 24"W x 46"L x .25"T

AK, HM, PT, WK, WL



FLEXIBLE

**1/4" SQUARE FLEXIBLE TAMBOUR - .25" T**

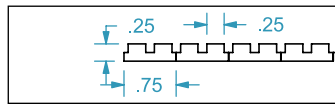

STYLE 302

**011248302-1** 12"W x 48"L x .25"T  
**011296302-1** 12"W x 96"L x .25"T  
**012448302-1** 24"W x 48"L x .25"T

AK, AL, CH, HM, PT, WK, WL



SOLID PANEL

**1/4" SQUARE SOLID TAMBOUR PANEL - .25" T**

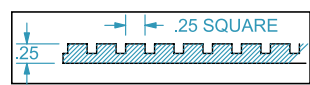

**012446302-1** 24"W x 46"L x .25"T

AK, HM, PT, WK, WL



FLEXIBLE

**1/2" SQUARE FLEXIBLE TAMBOUR - .25" T**

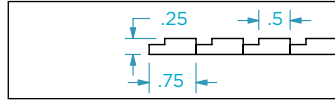

STYLE 304

**011248304-1** 12"W x 48"L x .25"T  
**011296304-1** 12"W x 96"L x .25"T  
**012448304-1** 24"W x 48"L x .25"T

AK, AL, CH, HM, PT, WK, WL



SOLID PANEL

**1/2" SQUARE SOLID TAMBOUR PANEL - .25" T**

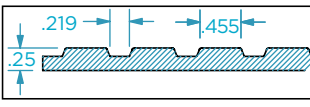

**012446304-1** 24"W x 46"L x .25"T

AK, HM, PT, WK, WL



FLEXIBLE

**5/8" COVE-CUT FLEXIBLE TAMBOUR - .25" T**

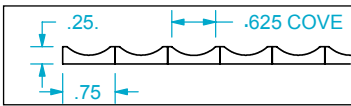

STYLE 403

**011248403-1** 12"W x 48"L x .25"T  
**011296403-1** 12"W x 96"L x .25"T  
**012448403-1** 24"W x 48"L x .25"T

AK, AL, CH, HM, PT, WK, WL



SOLID PANEL

**5/8" COVE-CUT SOLID TAMBOUR PANEL - .25" T**

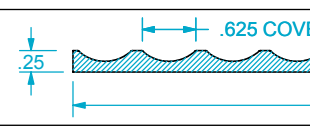

**012446403-1** 24"W x 46"L x .25"T

Metallic Trim Accents stocked in **Brushed Aluminum (BA)**, **Chrome (CR)**, **Flat Black (WR)**, **Polished Brass (PB)**, **Satin Brass (SB)**, **Satin Stainless (ST)**, & **Warm Bronze (WB)**. All components pictured in flat black.

### DECORATIVE ALUMINUM STRAPPING

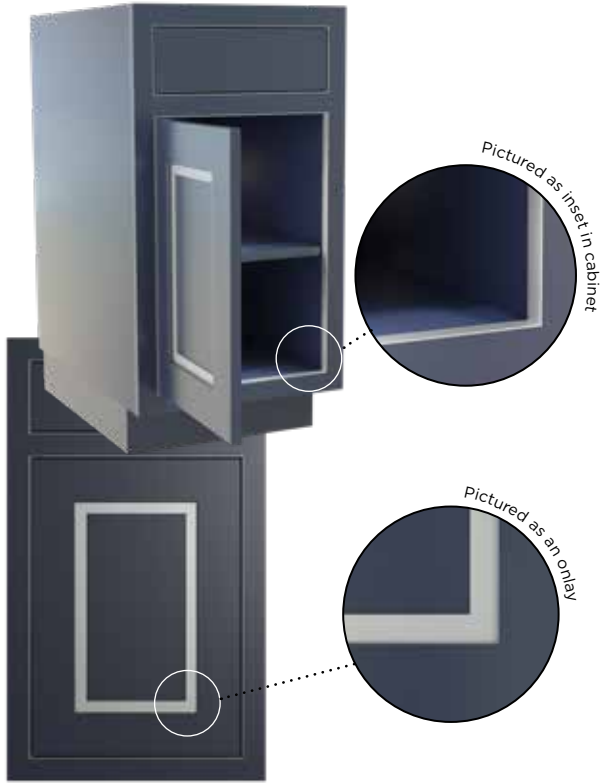

Pictured: .75" Decorative Aluminium Strapping in **Brushed Aluminum**

Use as trim on cabinetry or replace existing & outdated Light Rail Inserts with our new Decorative Aluminum Strapping. Shipped in 72" lengths, the straps can be cut on site to fit your specifications using a lubricated, non-ferrous, high tooth count (96 is recommended) carbide blade designed for cutting metal. We stock strong, double-sided, clear industrial tape that's temperature resistant to adhere to mouldings and cabinet panels. See tape on page 13.



**01STRAP7572-1**

.75"W x .063"T x 72"L

**01110171-1**

1.25"W x .094"T x 72"L

### ALUMINUM L-CHANNEL

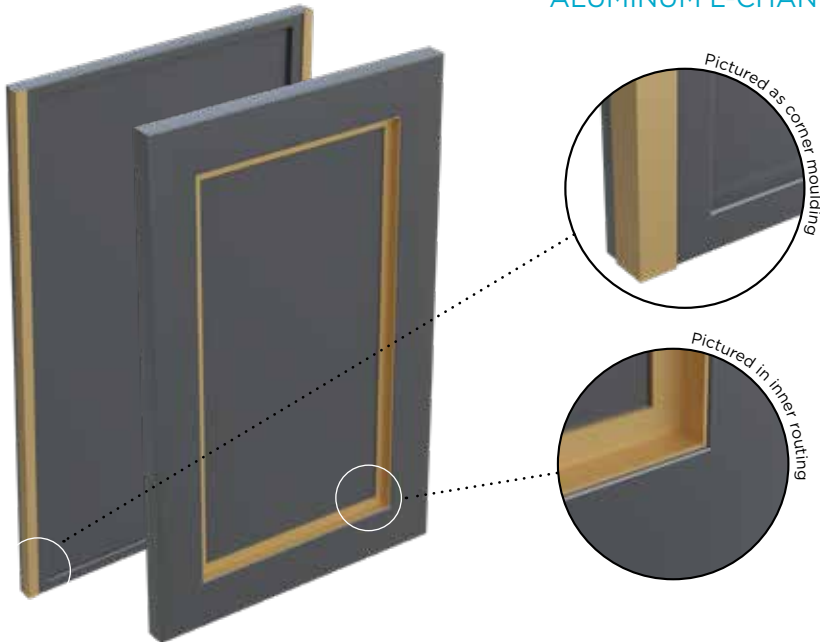

Pictured: .5" Aluminum L-Channel in **Satin Brass**



**01110030-1**

.5" each way x .063"T x 72"L







**01110451-1 NEW SIZE!**

.875" each way x .063"T x 72"L



Metallic Trim Sample Kits available.  
<http://qr.brownwoodinc.com/MetalTrimSampleKits>

**Metal Finishes**

-  **BA:** Brushed Aluminum
-  **CR:** Chrome
-  **PB:** Polished Brass
-  **SB:** Satin Brass
-  **ST:** Satin Stainless
-  **WB:** Warm Bronze
-  **WR:** Flat Black

# Designs of distinction®

Kitchen, Bath & Home by BWI

Metallic Trim Accents stocked in **Brushed Aluminum (BA), Chrome (CR), Flat Black (WR), Polished Brass (PB), Satin Brass (SB), Satin Stainless (ST), & Warm Bronze (WB)**. All components pictured in flat black.

## .25" x .75" ALUMINUM BAR

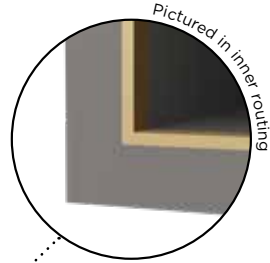

**01110788-1**  
.75"W X .25"T X 72"L

Pictured: .25" x .75" Aluminum Bar in **Satin Brass**

## .25" x .25" ALUMINUM BAR

### DESIGNER DRIPEDGE™

Fits standard door sizes for 15" and 18" waste can cabinets. Features eased ends and includes pre-applied UHB tape for easy installation. Available in **BA, WR, & SB**.



**01110451-12**

.875" Each Way x .0625"T x 12.75"L

**01110451-14**

.875" Each Way x .0625"T x 14.5"L

**01110451-15**

.875" Each Way x .0625"T x 15.75"L

**01110451-17**

.875" Each Way x .0625"T x 17.5"L

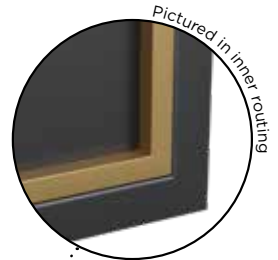

**01110810-1**  
.25"W X .25"T X 72"L

Pictured: .25" Aluminum Bar in **Satin Brass**



Our Decorative Brass Strapping offers an easy way to add a splash of brass to your designs. The flat brass bars are .375" W and 48" L and can be cut on site to fit your specifications using a lubricated, non-ferrous, high tooth count (96 is recommended) carbide blade designed for cutting metal. Combine with our decorative corner straps to finish the look. Available in **Polished Brass (PB)**.

**.375" BRASS STRAPPING**



**01HC1007PB1**  
 .375"W X .063"T X 48"L

**.375" BRASS CORNER STRAP**



**01HC1006PB1**  
 1.5"L X .04"T X .375"W

**UHB Tape**



**01TP50-108**  
 1/2"W X 108'L  
**01TP50-8**  
 1/2"W X 8'L

**01TP1875-54**  
 3/16"W X 54'L  
**01TP1875-8**  
 3/16"W X 8'L

Double-sided tape, with acrylic-based adhesive, ideal for use with our metal bars, trim and strapping.



Pictured: .375" Brass Strapping and .375" Brass Corner Strap

Decorative Brass hardware is stocked in **Polished Brass (PB)** and **Antique Brass (AB)**.



**01HC1005-1**  
 1.5"L X .08"T X .5"W



**01HC1004-1**  
 1.5"L X .08"T X .375"W



**01HC1003-1**  
 1.5"L X .08"T X 2.1"W



**01HC1002-1**  
 1.5"L X .08"T X 2"W



**01HC1009-1**  
 2"L X 2"D X 0.5"H



**01HC1001-1**  
 1.57"L X 0.12"T X 1.57"W  
 Also available in **CR**.



**01HC1000-1**  
 1.57" DIAM X .16"T  
 Also available in **CR**.

- Metal Finishes**
- AB:** Antique Brass
  - CR:** Chrome
  - PB:** Polished Brass

DECORATIVE GRILLES

Available Cut-to-Size or as whole and half sheets.

All Decorative Grilles available in **Antique Brass (AB)**, **NEW! Antique Copper (AC)**, **Antique Pewter (AP)**, **Satin Brass (SB)**, **Polished Satin Nickel (SN)**, **Stainless Look (SS)** & **Flat Black (WR)**. Finishes created through an electroplating process.

To order Cut-to-Size panels that are ready to install upon delivery, contact us or send us an order form with your panel specifications and a quote will be provided based on square footage used in your project.

Sample Kits available on our website.

**Decorative Grille & Mesh**

Grille & mesh can be used on their own or combined for a layered look.

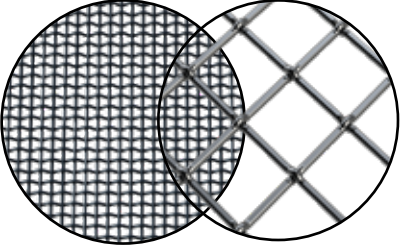



Cut-to-Size Order Form.  
<http://qr.brownwoodinc.com/OrderForms>

**.1875" FLAT SQUARE**

Pictured in **Satin Brass**

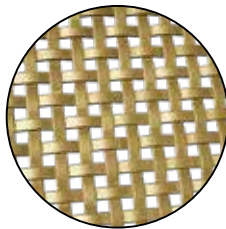

**Half Sheets:**  
**013624RE25-1**  
36" W x 24" H  
**011848RE25-1**  
18" W x 48" H

**Whole Sheet:**  
**013648RE25-1**  
36" W x 48" H

**.75" PRESSED SINGLE DIAMOND**

Pictured in **Polished Satin Nickel**

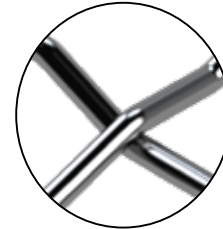
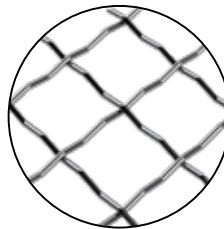

**Half Sheets:**  
**013624315C-1**  
36" W x 24" H  
**011848315C-1**  
18" W x 48" H

**Whole Sheet:**  
**013648315C-1**  
36" W x 48" H

**.5" STRAIGHT FLAT DIAMOND**

Pictured in **Antique Brass**

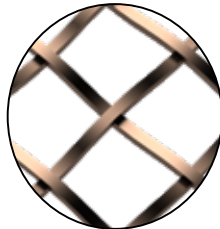
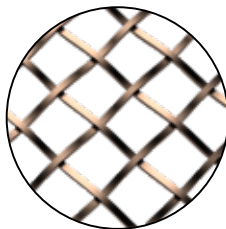

**Half Sheets:**  
**013624CG10-1**  
36" W x 24" H  
**011848CG10-1**  
18" W x 48" H

**Whole Sheet:**  
**013648CG10-1**  
36" W x 48" H

**.5" ROUND SINGLE DIAMOND\***



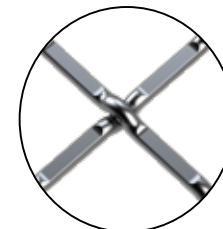
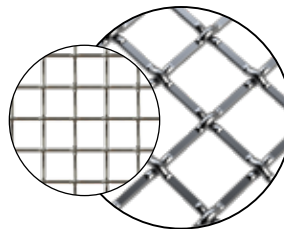



Pictured in **Polished Satin Nickel**



**Half Sheets:**  
**0136241214F-1**  
36" W x 24" H  
**0118481214F-1**  
18" W x 48" H

**Whole Sheets:**  
**0136481214F-1**  
36" W x 48" H  
**0124721214F-1**  
24" W x 72" H

**Metal Finishes**

-  **AB:** Antique Brass
-  **AC:** Antique Copper
-  **AP:** Antique Pewter
-  **SB:** Satin Brass
-  **SN:** Polished Satin Nickel
-  **SS:** Stainless Steel Look
-  **WR:** Flat Black

Custom styles and finishes available upon request.

\* Can be installed in the traditional diamond configuration or flipped to square for a contemporary look.

**Available Cut-to-Size or as whole and half sheets.**

All Decorative Grilles available in **Antique Brass (AB)**, **NEW! Antique Copper (AC)**, **Antique Pewter (AP)**, **Satin Brass (SB)**, **Polished Satin Nickel (SN)**, **Stainless Steel Look (SS)** & **Flat Black (WR)**. Finishes created through an electroplating process.

To order Cut-to-Size panels that are ready to install upon delivery, contact us or send us an order form with your panel specifications and a quote will be provided based on square footage used in your project. Sample Kits available on our website.

**5" CHICKEN WIRE**

Pictured in **Flat Black**

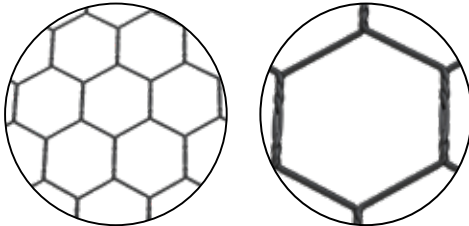

**Half Sheets:**  
**0118481220T-1**  
18" W x 48" H  
**0136241220T-1**  
36" W x 24" H

**Whole Sheet:**  
**0136481220T-1**  
36" W x 48" H

Chicken Wire only comes in **AB**, **AP** and **WR**.

**.375" FLAT SINGLE DIAMOND\***

Pictured in **Antique Brass**

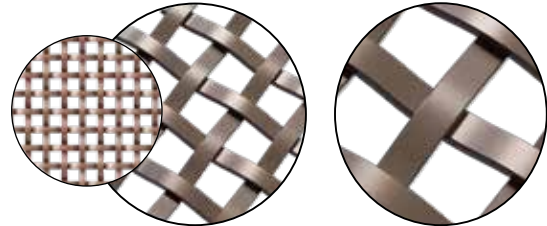

**Half Sheets:**  
**011848286S-1**  
18" W x 48" H  
**013624286S-1**  
36" W x 24" H

**Whole Sheets:**  
**013648286S-1**  
36" W x 48" H  
**012472286S-1**  
24" W x 72" H

**.75" MULTI-CRIMP SINGLE DIAMOND\***

Pictured in **Antique Pewter**

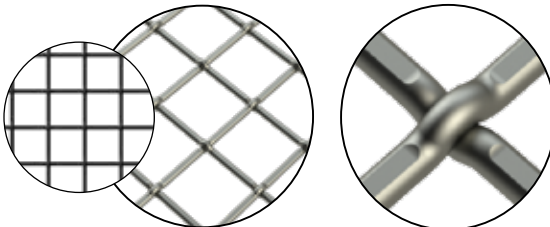

**Half Sheets:**  
**011848332P-1**  
18" W x 48" H  
**013624332P-1**  
36" W x 24" H

**Whole Sheets:**  
**013648332P-1**  
36" W x 48" H  
**012472332P-1**  
24" W x 72" H

**1" FLAT DOUBLE DIAMOND**

Pictured in **Satin Brass**

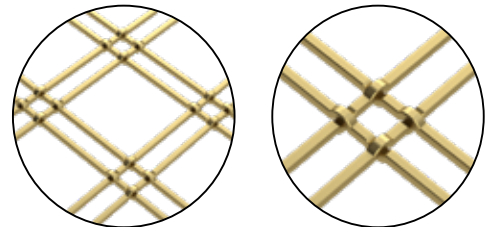

**Half Sheets:**  
**01184811614P-1**  
18" W x 48" H  
**01362411614P-1**  
36" W x 24" H

**Whole Sheets:**  
**01364811614P-1**  
36" W x 48" H  
**01247211614P-1**  
24" W x 72" H

**DOUBLE-SIDED .375" FLAT/FLUTED\***

Pictured in **Antique Brass**

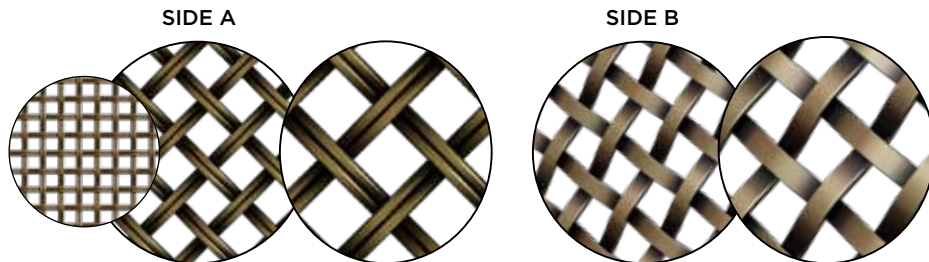







**Half Sheets:**  
**011848DK08-1**  
18" W x 48" H  
**013624DK08-1**  
36" W x 24" H

**Whole Sheets:**  
**013648DK08-1**  
36" W x 48" H  
**012472DK08-1**  
24" W x 72" H



Cut-to-Size Order Form

**Metal Finishes**

-  **AB:** Antique Brass
-  **AC:** Antique Copper
-  **AP:** Antique Pewter
-  **SB:** Satin Brass
-  **SN:** Polished Satin Nickel
-  **SS:** Stainless Steel Look
-  **WR:** Flat Black

Custom styles and finishes available upon request.

\* Can be installed in the traditional diamond configuration or flipped to square for a contemporary look.



**Available Cut-to-Size or as whole and half sheets.**

All Decorative Grilles with Rosettes only available in **Antique Brass (AB)**. Finishes created through an electroplating process. To order Cut-to-Size panels that are ready to install upon delivery, contact us or send us an order form with your panel specifications and a quote will be provided based on square footage used in your project. Sample Kits available on our website.

**.75" MULTI-CRIMP SINGLE DIAMOND WITH .5" ROSETTES**

Pictured in **Antique Brass**

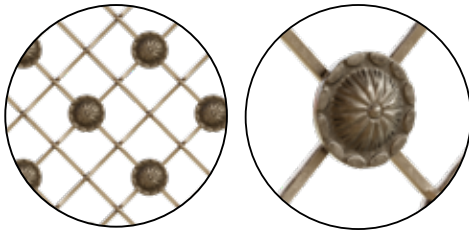

**Half Sheets:**  
**011848R332PAB1**  
 18" W x 48" H  
**013624R332PAB1**  
 36" W x 24" H

**Whole Sheets:**  
**013648R332PAB1**  
 36" W x 48" H

**1" FLAT DOUBLE DIAMOND WITH .625" DIAMETER ROSETTES**

Pictured in **Antique Brass**

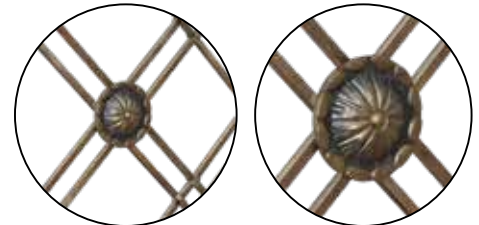

**Half Sheets:**  
**011848R614PAB1**  
 18" W x 48" H  
**013624R614PAB1**  
 36" W x 24" H

**Whole Sheets:**  
**013648R614PAB1**  
 36" W x 48" H

**HEX RATTAN**

Available in rolls or Cut-to-Size.

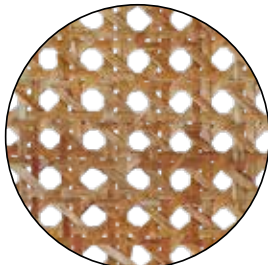

**Natural**  
**0124481202NT1**  
 24" x 48" roll

**HERRINGBONE RATTAN**

Available in rolls or Cut-to-Size.

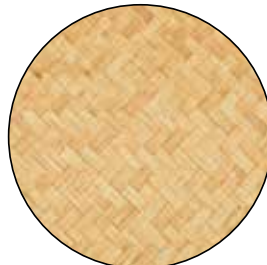

**Herringbone**  
**0124481203NT1**  
 24" x 48" roll

**BASKET WEAVE RATTAN**

Available in rolls or Cut-to-Size.

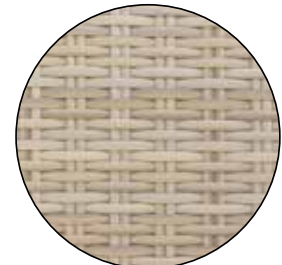

**Basket Weave**  
**0124481204NT1**  
 24" x 48" roll

**WHITE LINEN RESIN**

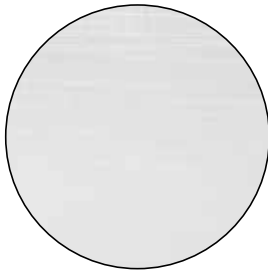

**Whole Sheet: 0148481803**  
 48" x 48"  
**Half Sheet: 0124481803**  
 48" x 24"

**BOTANICAL RESIN**



**Whole Sheet: 0148481804**  
 48" x 48"  
**Half Sheet: 0124481804**  
 48" x 24"

**NATURAL LEAF RESIN**



**Whole Sheet: 0148481802**  
 48" x 48"  
**Half Sheet: 0124481802**  
 48" x 24"

Sample Kits available. See QR code on page 17.

Available Cut-to-Size or as sheets.

FINE WIRE MESH

Pictured in Flat Black

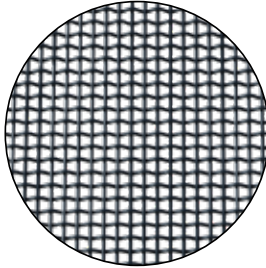

**Whole Sheet: 014448MESH-1**

41" L x 48" W

**Half Sheet: 012248MESH-1**

20" L x 48" W

Available in **SB, SN, WR**

GRILLE RETAINER



**01DGRETAINER-1**

Cut-to-Size to fit your decorative grille.  
 Transparent vinyl. Sold per linear foot.

ITALIAN MESH

Made in Italy. Available Cut-to-Size or as sheets.

CHEVRON MESH

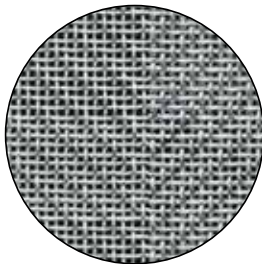

**015936107-1**

59" W x 36" H

**Whole Sheet**

Available in **SB, SS**

PINSTRIP MESH

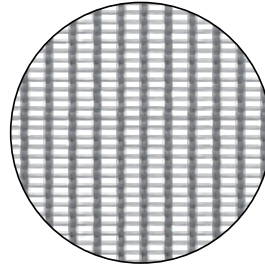

**015936104SS1**

59" W x 36" H

**Whole Sheet**

Available in **SS**

BAR CODE MESH

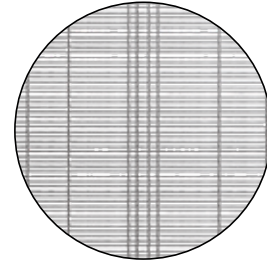

**015936116SS1**

59" W x 36" H

**Whole Sheet**

Available in **SS**

BENGAL MESH

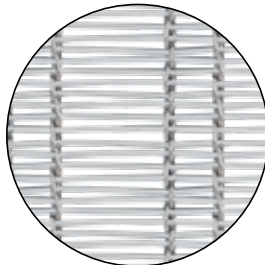

**015936118SS1**

59" W x 36" H

**Whole Sheet**

Available in **SS**

JUTE MESH

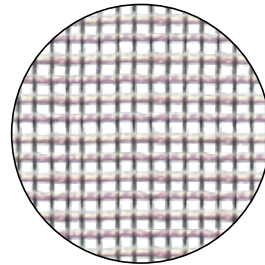

**015936112SS1**

59" W x 36" H

**Whole Sheet**

Available in **SS**



Cut-to-Size Sample Kits available.  
<http://qr.brownwoodinc.com/CTSSampleKits>

DOUBLE-SIDED ECO-FRIENDLY LEATHER

Available Cut-to-Size or as whole and half sheets.

Our leather is an eco-friendly byproduct of the leather industry. Like wood veneer made from compressed paper, this leather is composed of vegetable-tanned leather remnants that are pulverized and mixed with small amounts of tree bark and natural latex. A final layer of resin renders the product highly impervious to wear and tear. Sample kits available.

PEBBLED LEATHER  
BRIGHT WHITE

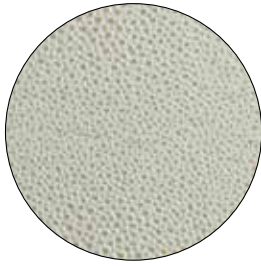

**Whole Sheet: 0148481652BW1**  
48" x 48"  
**Half Sheet: 0124481652BW1**  
48" x 24"

PEBBLED LEATHER  
WALNUT

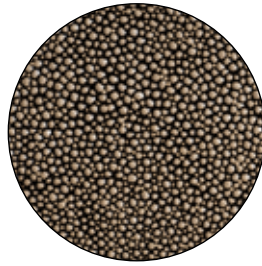

**Whole Sheet: 0148481652WL1**  
48" x 48"  
**Half Sheet: 0124481652WL1**  
48" x 24"

PEBBLED LEATHER  
ESPRESSO

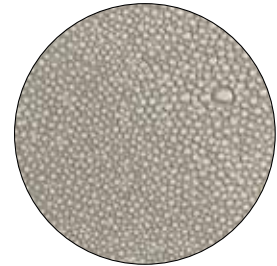

**Whole Sheet: 0148481652ES1**  
48" x 48"  
**Half Sheet: 0124481652ES1**  
48" x 24"

PEBBLED LEATHER  
FLAT BLACK



**Whole Sheet: 0148481652WR1**  
48" x 48"  
**Half Sheet: 0124481652WR1**  
48" x 24"

GRAINED LEATHER  
BRIGHT WHITE



**Whole Sheet: 0148482216BW1**  
48" x 48"  
**Half Sheet: 0124482216BW1**  
48" x 24"

GRAINED LEATHER  
WALNUT



**Whole Sheet: 0148482216WL1**  
48" x 48"  
**Half Sheet: 0124482216WL1**  
48" x 24"

GRAINED LEATHER  
ESPRESSO



**Whole Sheet: 0148482216ES1**  
48" x 48"  
**Half Sheet: 0124482216ES1**  
48" x 24"

GRAINED LEATHER  
FLAT BLACK



**Whole Sheet: 0148482216WR1**  
48" x 48"  
**Half Sheet: 0124482216WR1**  
48" x 24"



Leather Sample Kits available.  
<http://qr.brownwoodinc.com/LeatherSampleKit>





**Available Species and Finishes**

**Wood Species**

- AK:** Red Oak
- AL:** Alder
- CH:** Cherry
- HM:** Hard Maple
- HK:** Hickory
- PT:** Paint Grade
- WK:** White Oak
- WL:** Walnut

**Metal Sleeve Finishes**

- BA:** Brushed Aluminum
- CR:** Chrome
- GL:** Soft Gold
- PB:** Polished Brass
- SB:** Satin Brass
- ST:** Satin Stainless
- WB:** Warm Bronze
- WR:** Flat Black

We offer Special Cuts & Secondary Services to help you in your design process. Secondary services such as splitting in half and electrical outlet routing are available on many of our posts, columns, and table legs. See page 5 for more information.

**Featured: Palladian Column**



QUEEN ANNE  
FRENCH



**01180210-1**

2.375" SQ. x 36.5" H

QUEEN ANNE  
FRENCH FLUTED



**01180240-1**

2.375" SQ. x 36.5" H

CORNER POST



**01550210-1**

2.75" SQ. x 36.5" H

CORNER  
POST FLUTED



**01550240-1**

2.75" SQ. x 36.5" H

CH, HM

BUNGALOW

AK, AL, CH, HM, PT, WK, WL



**01510228-1**

3" SQ. x 34.5" H



**01515028-1**

5" SQ. x 34.5" H



**01510328-1**

3" SQ. x 42.25" H

NOUVEAU

AK, AL, CH, HM, PT



**01250210-1**

3.5" SQ. x 35.25" H



**01250310-1**

5.5" SQ. x 41" H

2" TABLE POSTS

2" SQUARE

2" SQUARE NOTCHED

AK, AL, CH, HM, HK, PT, WK, WL



**01612010-1**  
 2" SQ. x 29" H

**01612010-3**  
 2" SQ. x 29" H

2" DADOED SQUARE COLUMN  
 W/ METAL SLEEVE

2" SQUARE W/  
 TAPERED FOOT

2" SQUARE  
 W/ TAPERED  
 FOOT & NOTCH

AK, AL, CH, HM, HK, PT, WK, WL



**01722910-1\***  
 2" SQ. x 29"H  
 with 2" SQ. sleeve

**01724529-1**  
 2" SQ. x 29"H with  
 2" SQ. x 4.5"H sleeve

**01621025-1**  
 2" SQ. x 29" H

**01621025-3**  
 2" SQ. x 29" H

\*For a complete list of sleeve finishes, see page 1.

2" ISLAND POSTS

2" SQUARE

2" DADOED SQUARE COLUMN  
 W/ METAL SLEEVE

AK, AL, CH, HM, HK, PT, WK, WL



**01622010-1**

2" SQ. x 35.25" H



**01724500-1\***

2" SQ x 35.25" H  
 with 2" SQ. x 4.5"H sleeve



**01722010-1\***

2" SQ. x 35.25" H  
 with 2" SQ. sleeve

2" SQUARE NOTCHED

2" SQUARE W/ TAPERED FOOT

AK, AL, CH, HM, HK, PT, WK, WL



**01622010-3**

2" SQ. x 34.5" H



**01622025-3**

2" SQ. x 34.5" H



**01622025-1**

2" SQ. x 35.25" H

\*For a complete list of sleeve finishes, see page 1.

3" TABLE AND ISLAND POSTS

SQUARE

TAPERED FOOT

BEVEL CUT

DADOED SQUARE  
 COLUMN W/  
 METAL SLEEVE

AK, AL, CH, HM, HK, PT, WK, WL



**01613010-1**  
 3" SQ. x 29" H



**01613025-1**  
 3" SQ. x 29" H



**01621729-1**  
 3" SQ. x 29" H



**01723001-1\***  
 3" SQ. x 29" H with  
 3" SQ. sleeve

SQUARE

TAPERED FOOT

BEVEL CUT

DADOED SQUARE COLUMN  
 W/ METAL SLEEVE

AK, AL, CH, HM, HK, PT, WK, WL



**01623010-1**  
 3" SQ. x 35.25" H



**01623025-1**  
 3" SQ. x 35.25" H



**01623017-1**  
 3" SQ. x 35.25" H



**01723010-1\***  
 3" SQ. x 35.25" H with  
 3" SQ. sleeve



**01734510-1\***  
 3" SQ. x 35.25" H with  
 3" SQ. 4.5" sleeve

\*For a complete list of sleeve finishes, see page 1.



4" TABLE AND ISLAND POSTS

4" SQUARE



**01614010-1**  
 4" SQ. x 29" H

4" SQUARE  
 W/ TAPERED FOOT



**01614025-1**  
 4" SQ. x 29" H

4" DADOED  
 SQUARE COLUMN  
 W/ METAL SLEEVE



**01724001-1\***  
 4" SQ. x 29"H with  
 4" SQ. sleeve

AK, AL, CH, HM, HK, PT, WK, WL

4" SQUARE



**01624010-1**  
 4" SQ. x 35.25" H

4" SQUARE  
 W/ TAPERED FOOT



**01624025-1**  
 4" SQ. x 35.25" H

4" DADOED  
 SQUARE COLUMN  
 W/ METAL SLEEVE



**01724010-1**  
 4" SQ. x 35.25" with  
 4" SQ. sleeve

AK, AL, CH, HM, HK, PT, WK, WL

\*For a complete list of sleeve finishes, see page 1.

5" & 6" TABLE AND ISLAND POSTS

5" DADOED SQUARE COLUMN  
 W/ METAL SLEEVE



**01725001-1**

5" SQ. x 29"H with  
 5" SQ. sleeve  
 Sleeve only available in BA & WR.

5" SQUARE COLUMN  
 AK, AL, CH, HM, HK, PT, WK, WL



**01615010-1**

5" SQ. x 29"H

5" DADOED SQUARE  
 COLUMN W/ METAL SLEEVE



**01625010-1**

5" SQ. x 35.25"H



**01725010-1**

5" SQ. x 35.25"H  
 with 5" SQ. sleeve  
 Sleeve only available in BA & WR.

6" SQUARE MITER LOCK

AK, AL, CH, HM, HK, PT, WK, WL



**01606010-1**

6" SQ. x 34.5"H

6" SQUARE



**01626010-1**

6" SQ. x 35.25"H

BAR HEIGHT POSTS

2" SQUARE      2" DADOED SQUARE COLUMN W/ METAL SLEEVE      3" SQUARE      3" DADOED SQUARE COLUMN W/ METAL SLEEVE

AK, AL, CH, HM, PT



**01632010-1**  
 2" SQ. x 42.25" H



**01732010-1\***  
 2" SQ. x 42.25"H  
 with 2" SQ. sleeve



**01633010-1**  
 3" SQ. x 42.25" H



**01733010-1\***  
 3" SQ. x 42.25"H  
 with 3" SQ. sleeve

4", 5" & 6" SQUARE

AK, AL, CH, HM, PT



**01634010-1**  
 4" SQ. x 42.25" H



**01635010-1**  
 5" SQ. x 42.25" H



**01636010-1**  
 6" SQ. x 42.25" H



**01734010-1\***  
 4" SQ. x 42.25"H with  
 4" SQ. sleeve



**01735010-1\***  
 5" SQ. x 42.25"H with  
 5" SQ. sleeve  
 Sleeve only available in BA & WR.

\*For a complete list of sleeve finishes, see page 1.

JACOBSEN

AK, AL, CH, HM, PT, WL



**01270110-1**  
 2.25" SQ. x 29" H



**01280110-1**  
 2.75" SQ. x 29" H



**01270210-1**  
 2.25" SQ. x 34.5" H



**01280210-1**  
 2.75" SQ. x 34.5" H

JACOBSEN NOTCHED

AK, AL, CH, HM, PT, WL



**01270110-3**  
 2.25" SQ. x 29" H



**01280110-3**  
 2.75" SQ. x 29" H



**01270210-3**  
 2.25" SQ. x 34.5" H



**01280210-3**  
 2.75" SQ. x 34.5" H



DANISH MODERN

AK, AL, CH, HM, PT, WL



**01310110-1** 2.625" DIAM. x 29" H  
**01310210-1** 2.625" DIAM. x 34.5" H

DANISH MODERN NOTCHED



**01310210-3** 2.625" DIAM. x 34.5" H  
**01310110-3** 2.625" DIAM. x 29" H

2 SIDED SQUARE TAPERED

AK, AL, CH, HM, PT



**01530210-1** 3.75" SQ. x 35.25" H  
**01530310-1** 3.75" SQ. x 42.25" H

4 SIDED SQUARE TAPERED

AK, AL, CH, HM, HK, PT, WL



**01540210-1** 3.75" SQ. x 35.25" H  
**01540310-1** 3.75" SQ. x 42.25" H

ESTATE FLUTED

CH, HM, PT



**01040240-1** 3.75" SQ. x 35.25" H

ESTATE ROUND

AK, AL, CH, HM, PT, WK, WL



**01040210-1** 3.75" SQ. x 35.25" H

CHARLESTON BEAD  
W/ FOOT



**01010285-1**  
3" SQ. x 35.25" H

CHARLESTON BEAD



**01010280-1**  
3" SQ. x 35.25" H

CHARLESTON BEAD DOUBLE  
SQUARE



**01020280-1**  
3" SQ. x 35.25" H

ROPE

AK, AL, CH, HM, PT



**01510203-1**  
3.5" SQ. x 34.5" H

CHARLESTON PEDESTAL

AK, CH, HM, WL



**01290180-1**  
12" DIAM. x 29.5" H



**01290280-1**  
12" DIAM. x 33.5" H

ENGLISH COUNTRY  
 AK, AL, CH, HM, HK, PT



**01000110-1**  
 3.75" SQ. x 29.25" H



**01210110-1**  
 5" SQ. x 29.25" H



**01000210-1**  
 3.75" SQ. x 35.25" H

ENGLISH COUNTRY  
 AK, AL, CH, HM, PT



**01210210-1**  
 5" SQ. x 35.25" H



**01000310-1**  
 3.75" SQ. x 42.25" H

ENGLISH COUNTRY  
 DOUBLE SQUARE  
 AK, AL, CH, HM, PT



**01030210-1**  
 3.75" SQ. x 35.25" H

SUMTER DOUBLE SQUARE  
 AK, AL, CH, HM, PT



**01470110-1**  
 5" SQ. x 30.25" H



**01470210-1**  
 5" SQ. x 35.25" H

SUMTER WITH FOOT  
 AK, AL, CH, HM, PT



**01370210-1**  
 5" SQ. x 35.25" H

GAELIC

AK, AL, CH, HM, PT, WK, WL



<b>01590122-1</b> 3.5" SQ. x 29" H	<b>01590124-1</b> 4.5" SQ. x 29" H	<b>01590127-1</b> 6" SQ. x 29" H	<b>01590222-1</b> 3.5" SQ. x 34.5" H	<b>01590224-1</b> 4.5" SQ. x 35.5" H	<b>01590227-1</b> 6" SQ. x 35.5" H
---------------------------------------	---------------------------------------	-------------------------------------	---	---	---------------------------------------

GAELIC - ROUTED

AK, AL, CH, HM, PT, WK, WL



<b>01590123-1</b> 3.5" SQ. x 29" H	<b>01590125-1</b> 4.5" SQ. x 29" H	<b>01590128-1</b> 6" SQ. x 29" H	<b>01590223-1</b> 3.5" SQ. x 34.5" H	<b>01590225-1</b> 4.5" SQ. x 35.5" H	<b>01590228-1</b> 6" SQ. x 35.5" H
---------------------------------------	---------------------------------------	-------------------------------------	---	---	---------------------------------------



WRIGHT

WRIGHT W/  
 DETACHABLE FOOT

KENSINGTON

AK, AL, CH, HM, PT, WK, WL



**01040270-1**  
 3.5" SQ. x 35.25"H



**01040275-1**  
 3.5" SQ. x 35.25"H



**01110110-1**  
 3" SQ. x 29"H



**01110210-1**  
 3" SQ. x 35.25"H

ESTATE SQUARE

AK, AL, CH, HM, PT, WK, WL



**01042760-1**  
 2.75" SQ. x 35.25" H



**01040127-1**  
 2.75" SQ. x 29.25" H



**01040160-1**  
 3.75" SQ. x 29.25" H



**01220160-1**  
 5" SQ. x 29.25" H  
 ONLY CH, HM, PT



**01220260-1**  
 5" SQ. x 35.25" H  
 ONLY CH, HM, PT



**01040260-1**  
 3.75" SQ. x 35.25" H

COUNTRY FRENCH SQUARE

COUNTRY FRENCH DOUBLE SQUARE

CH, HM, PT



**01060160-1**

3.75" SQ. x 29.25" H

**01060260-1**

3.75" SQ. x 35.25" H



**01410110-1**

5" SQ. x 29" H

**01050210-1**

3.75" SQ. x 35.25" H

**01410210-1**

5" SQ. x 35.25" H

COUNTRY FRENCH REEDED

COUNTRY FRENCH

CH, HM, PT



**01060220-1**

3.75" SQ. x 35.25" H



**01060110-1**

3.75" SQ. x 29.25" H



**01510110-1**

5" SQ. x 29.25" H



**01510210-1**

5" SQ. x 35.25" H



**01060210-1**

3.75" SQ. x 35.25" H

TRADITIONAL DOUBLE SQUARE

AK, AL, CH, HM, PT

URN

BUFFET



**01160210-1**  
 3.5" SQ. x 34.5" H



**01160310-1**  
 3.5" SQ. x 40.5" H



**01560210-1**  
 3.75" SQ. x 35.25" H



**01520210-1**  
 5" SQ. x 35.25" H



**01590210-1**  
 3.75" SQ. x 34.5" H

ASTER

AK, AL, CH, HM, PT

COLONIAL

TRADITIONAL REEDED

CH, HM, PT

BAROQUE

CH, HM



**01510202-1**  
 3.5" SQ. x 34.5" H



**01510200-1**  
 3.5" SQ. x 34.5" H



**01150220-1**  
 3.5" SQ. x 34.5" H



**01610210-1**  
 3" W x 5.5" D x 34.5" H

\*Set of 3 Pieces

ROMAN CLASSIC FLUTED

ROMAN CLASSIC ROPED

AK, AL, CH, HM, PT



**01080240-1**  
 3.75" SQ. x  
 35.25" H

**01230240-1**  
 5" SQ. x  
 35.25" H

**01082740-1**  
 2.75" SQ. x  
 35.25" H

**01082730-1**  
 2.75" SQ. x  
 35.25" H

**01080230-1**  
 3.75" SQ. x  
 35.25" H

**01230230-1**  
 5" SQ. x  
 35.25" H

ROMAN CLASSIC

ROMAN CLASSIC WEAVED

AK, AL, CH, HM, HK, PT

CH, HM



**01082710-1**  
 2.75" SQ. x  
 35.25" H

**01080210-1**  
 3.75" SQ. x  
 35.25" H

**01230210-1**  
 5" SQ. x  
 35.25" H

**01080270-1**  
 3.75" SQ. x  
 35.25" H

**01230270-1**  
 5" SQ. x  
 35.25" H

EMPIRE ISLAND

AK, AL, CH, HM, PT



**01625046-1**  
 5" SQ. X 35.25" H

MISSION

AK, AL, CH, HM, PT, WK, WL



**01510204-1**  
 3" SQ. x 35.25" H



**01240210-1**  
 3" SQ. x 34.625" H



**01090215-1**  
 3.75" SQ. x 35.25" H



**01240310-1**  
 3.75" SQ. x 42.25" H

COSMO

AK, AL, CH, HM, PT, WK, WL



**01100211-1**  
 3.75" SQ. x 35.25" H

ARTS & CRAFTS



**01386050-1**  
 6.375"W x 1.625"T  
 x 34.5"H



**01626050-1**  
 6.375" SQ. X 34.5" H

MADLINE

AK, AL, CH, HM, PT



**01100218-1**  
 6" SQ. x 35.5" H



**01110218-1**  
 3" SQ. x 35.5" H



APEX

AK, AL, CH, HM, PT



**01570217-1**

3.5" SQ. x 34.5" H

**01570317-1**

3.5" SQ. x 40.5" H

PALLADIAN

AK, AL, CH, HM, PT, WK, WL



**01580217-1**

3.5" SQ. x 34.5" H

**01580317-1**

3.5" SQ. x 40.5" H

IONIC ACANTHUS

CH, HM



**01520223-1**

6" SQ. x 35.5" H

ACANTHUS



**01560222-1**

3.75" SQ. x 35.25" H

TULIP

AK, AL, CH, HM, PT









**01140210-1**

3.5" SQ. x 34.5" H



**Available Species**

-  **AK:** Red Oak
-  **AL:** Alder
-  **CH:** Cherry
-  **HM:** Hard Maple
-  **WK:** White Oak
-  **WL:** Walnut

**Featured: 3" Thick  
Hardwood X-Panel**

All Hardwood X-Panels available in **Red Oak (AK)**, **Alder (AL)**, **Cherry (CH)**, **Hard Maple (HM)**, **White Oak (WK)**, and **Walnut (WL)**. Custom species, sizes, and configurations available.

TRIMMABLE HARDWOOD X-PANEL

Features 7.5" Trimmable Bottom



**01XPN3025LNG-1**

25" W x 3" T  
 x 34.5" H



**01XPN3036LNG-1**

36" W x 3" T  
 x 34.5" H



**01XPN1525LNG-1**

25" W x 1.5" T  
 x 34.5" H

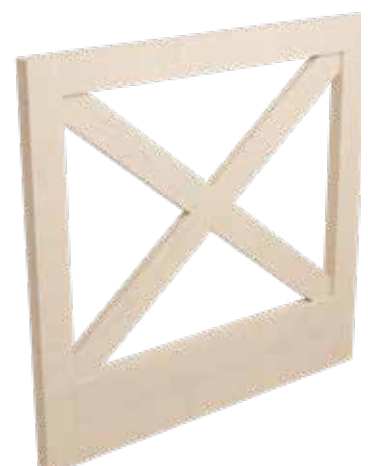

**01XPN1536LNG-1**

36" W x 1.5" T  
 x 34.5" H

HARDWOOD X-PANEL



**01XPNL3025-1**

25" W x 3" T x  
 34.5" H



**01XPNL3036-1**

36" W x 3" T  
 x 34.5" H



**01XPNL1525-1**

25" W x 1.5" T  
 x 34.5" H



**01XPNL1536-1**

36" W x 1.5" T x  
 34.5" H



Custom X-panel Order Form  
<http://qr.brownwoodinc.com/X-PanelOrderForm>

All hardwood X-Panels available in **AK, AL, CH, HM, WK, WL**. Custom species, sizes and configurations available.

TRIMMABLE HARDWOOD X-PANEL WITH BACKERS

Features 7.5" Trimmable Bottom



**01XPN3025LNG-4**  
 25" W x 3" T  
 x 34.5" H



**01XPN3036LNG-4**  
 36" W x 3" T  
 x 34.5" H



**01XPN1525LNG-4**  
 25" W x 1.5" T  
 x 34.5" H



**01XPN1536LNG-4**  
 36" W x 1.5" T  
 x 34.5" H

HARDWOOD X-PANEL BACKERS



**01XPNL3025-4**  
 25" W x 3" T x  
 34.5" H



**01XPNL3036-4**  
 36" W x 3" T  
 x 34.5" H



**01XPNL1525-4**  
 25" W x 1.5" T  
 x 34.5" H



**01XPNL1536-4**  
 36" W x 1.5" T  
 x 34.5" H

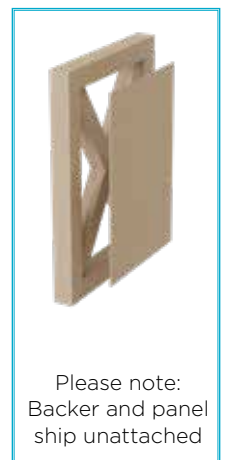

Please note:  
 Backer and panel  
 ship unattached

Our new X-Bases are eye-catching with clean lines and are sure to provide beautiful support to your tables, countertops & islands for years to come.



STEEL X-BASES  
 WR



**01XBS2824WR1**  
 23.46" W x 2.3" T x 28" H



**01XBS3424WR1**  
 24" W x 2.362" T x 34.5" H



**01XBS3436WR1**  
 36" W x 2.362" T x 34.5" H



CONTEMPORARY X-BASES - TABLE HEIGHT  
 SS, WR



**01XCONT2824WR1**  
 23.46" W x 3.07" T x 27.3" H











**01XCONT2824SS1**  
 23.46" W x 3.07" T x 27.3" H

**Metal Finishes**  
 **SS:** Stainless Steel  
 **WR:** Flat Black - Powder Coated Steel







### Available Species and Finishes

#### Wood Species

-  **AK:** Red Oak
-  **AL:** Alder
-  **CH:** Cherry
-  **HM:** Hard Maple
-  **HK:** Hickory
-  **PT:** Paint Grade
-  **WK:** White Oak
-  **WL:** Walnut

#### Metal Sleeve Finishes

-  **BA:** Brushed Aluminum
-  **CR:** Chrome
-  **GL:** Soft Gold
-  **PB:** Polished Brass\*
-  **SB:** Satin Brass
-  **ST:** Satin Stainless\*
-  **WB:** Warm Bronze
-  **WR:** Flat Black

**\*NEW finishes!**

**Featured: Toe Kick Foot with  
Satin Brass Sleeve**

SPECIALTY FEET

HAND CARVED CENTER PEDESTAL

CH, HM



**01708310-1**  
 2.5" H x 16" W

HAND CARVED CORNER PEDESTAL



**01708010-1**  
 8.25" W x 8.25" W x 4" H

HAMPTON MOULDING

AK, AL, CH, HM, PT



**01703310-1**  
 2" H x 1.5" T x 10" W

HAND CARVED  
 LEFT & RIGHT PEDESTAL SET

CH, HM



SOLD AS A SET

**01708110-1**  
 4" H x 8.25" W

HAMPTON LEFT

HAMPTON CORNER

HAMPTON RIGHT

AK, AL, CH, HM, PT



**01703110-1**  
 4.5" H x 1.5" T x 6" W



**01703010-1**  
 4.5" H x 1.5" T x 6" L x 6" L



**01703210-1**  
 4.5" H x 1.5" T x 6" W

SPECIALTY FEET

PERLE



**01245106-1** 2.25" DIAM. x 6" H  
**01245109-1** 2.75" DIAM. x 9" H

ROUND TAPERED

MA, WK, WL



**01243006-1** 1.5" DIAM. x 6" H  
**01243009-1** 1.87" DIAM. x 9" H

SQUARE TAPERED



**01244006-1** 1.5" SQ. x 6" H  
**01244009-1** 1.87" SQ. x 9" H

HAND CARVED ACANTHUS CORNER

CH, HM



**01707710-1** 3.375" SQ. x 4.5" H  
**01707610-1** 3.625" SQ. x 6" H

ACANTHUS



**01702022-1** 4" DIAM. x 4.5" H

SCROLL

CH, HM, PT



**01709010-1** 3.25" D. x 3.25" W x 4.5" H

HAND CARVED BELLA SMOOTH

CH, HM



**01707410-1** 3.75" DIAM. x 8" H

HAND CARVED BELLA FLUTED



**01707440-1** 3.75" DIAM. x 8" H

SQUARE TURNED FEET

NOUVEAU

METRO

TULIP SQUARE

AK, AL, CH, HM, PT, WK, WL



**01700457-1**  
4" SQ. x 4" H



**01705710-1**  
4" SQ. x 4.5" H



**01706065-1**  
3.5" SQ. x 4.625" H

SUMMIT

LILLE SQUARE

EMPIRE

ENGLISH ESTATE

AK, AL, CH, HM, PT



**01705080-1**  
4" SQ. x 4.5" H



**01750460-1**  
4" SQ. x 4" H



**01704060-1**  
4" SQ. x 4.5" H



**01700146-1**  
3" SQ. x 4.5" H



**01742060-1**  
3.5" SQ. x 4.5" H

LIAM

AIDEN

AK, AL, CH, HM, PT, WK, WL



**01700627-1**  
4.62" SQ. x 6" H



**01700327-1**  
3.625" SQ. x 4" H

**SQUARE AND TAPERED FEET**

BUN FEET

CRAFTSMAN CORNER

SQUARE TAPERED

SQUARE CRAFTSMAN

APEX

AK, AL, CH, HM, HK, PT, WK, WL



**01705175-1**

3.75" W x 3.75" W x 6" H



**01705610-1**

1.875" SQ. x 6" H



**01705112-1**

3" SQ. x 6" H



**01705150-1**

2.75" SQ. x 4" H

KENSINGTON

SQUARE COLUMN BASE

SHAKER

AK, AL, CH, HM, PT



**01703510-1**

3" SQ. x 4.5" H



**01705510-1**

3.75" SQ. x 4" H



**01705810-1**

5" SQ. x 5" H



**01705860-1**

6" SQ. x 4.5" H



**01705715-1**

4.5" SQ. x 4.5" H

2" SQUARE LEG  
W/ TAPER

3" SQUARE LEG  
W/ TAPER

AK, AL, CH, HM, PT, WK, WL

STRATFORD

WRIGHT

AK, AL, CH, HM, HK, PT, WK, WL



**01700210-1**

2" SQ. x 10" H



**01700310-1**

3" SQ. x 10" H



**01705110-1**

2.375" SQ. x 6" H



**01704075-1**

3" SQ. x 4.5" H  
(6.5" overall height)



TOE KICK FEET

TULIP



**01706060-1**  
 4" W x 2.5" T x 4.625" H

PALLADIAN



**01700018-1**  
 4" W x 2.5" T x 4.5" H

TOE KICK



**01705515-1**  
 3.75"W x 2.5"D x 4"H

TULIP

AK, CH, HM



**01706061-1**  
 4" W x 2.5" D x 4.125" H

APEX

AK, AL, CH, HM, HK,  
 PT, WK, WL



**01705155-1**  
 2.5" W x 2.5" D x 4" H

TAPERED

HM



**01705225-1**  
 3.5" SQ. x 4.5" H



Featuring: Apex Toe Kick Foot

ROUND FEET

BUN FEET

CLASSIC



**01705310-1**

3.625" DIAM. x 4.5" H

CRAFTSMAN

AK, AL, CH, HM, PT



**01760410-1**

3.625" DIAM. x 4" H



**01704210-1**

3.625" DIAM. x 4.5" H

TULIP



**01706010-1**

3.5" DIAM. x 4.625" H

ABBE



**01700011-1**

2.5" DIAM. x 4" H

COUNTRY FRENCH

AK, AL, CH, HM, PT



**01702510-1**

3.625" DIAM. x 4" H



**01700015-1**

3.875" DIAM. x 4.5" H

MADISON



**01704110-1**

3" DIAM. x 6.125" H

DANISH MODERN

AK, AL, CH, HM, PT, WK, WL



**01704535-1**

2.25" DIAM. x 4.5" H



**01706035-1**

2.25" DIAM. x 6" H



**01709035-1**

2.25" DIAM. x 9" H

LILLE

AK, AL, CH, HM, PT



**01704010-1**

4" DIAM. x 4.5" H

LILLE FLUTED



**01704040-1**

4" DIAM. x 4.5" H

OXFORD

AK, AL, CH, HM, PT



**01704910-1**

4" DIAM. x 4.5" H

PETITE TULIP

AK, PT



**01706005-1**

2.75" DIAM. x 3" H

MIXED MATERIALS FEET

ROUND TAPERED  
LEGS W/ FERRULE

SQUARE TAPERED  
LEGS W/ FERRULE

TIPTOE  
W/ FERRULE

HM, WK, WL  
 Ferrule finishes: BA, CR, SB, WB, WR



**01240006-1**

1.5" DIAM. x 6" H

**01240009-1**

1.87" DIAM. x 9" H

**01241006-1**

1.5" SQ. x 6" H

**01241009-1**

1.87" SQ. x 9" H

**01242006-1**

2.75" DIAM. x 6" H

**01242009-1**

3.625" DIAM. x 9" H

10" TALL SQUARE LEG W/ METAL SLEEVE

AK, AL, CH, HM, HK, PT, WK, WL

TOE KICK FOOT W/ 4.5" METAL SLEEVE

BA, CR, PB, SB, ST, WB, WR



**01721010-1**

2" SQ. x 10" H

**01731010-1**

3" SQ. x 10" H

**01704245-1**

4" W x 2" T x 4.5" H

**01700245-1**

2" SQ. x 4.5" H

**01700345-1**

3" SQ. x 4.5" H

ALUMINUM SLEEVES

BA, CR, GL, NA, SB, ST, PB, WR

Pictured in Chrome



**01SLV2-1**

2" SQ. OUTER DIM.  
x .125" T x 2" H

**01SLV3-1**

3" SQ. OUTER DIM.  
x .125" T x 3" H

**01SLV4-1**

4" SQ. OUTER DIM. x  
.125" T x 4" H

**01SLV5-1**

5" SQ. OUTER DIM.  
x .125" T x 5" H  
\*BA, WR

For a complete list of sleeve finishes, see page 1. For more individual sleeves & ferrules, see page 51.

CHROME

ANGLE ROUND



**01700400CR1**  
 2.813" PLATE x 5.375" D  
 x 4.875" H

5" SQUARE CORNER



**01700402CR1**  
 4" SQ. x 5" H

ROUND CORNER



**01700012CR1**  
 4.134" PLATE x 5.906" D  
 x 6" H

STRAIGHT ROUND



**01700905CR1**  
 3.5" DIAM. x 4" H

SOLID BRASS

RUTLAND  
 PB, WR



**01700408-1**  
 7.189" H X 4.724"

DEVON  
 PB, SB



**01700406-1**  
 5.9" H X 4.04" PLATE

ESSEX  
 PB



**01700412-1**  
 7.18" H X 1.57" DIAM.

TYNE  
 PB



**01700410-1**  
 5.9" H X 1.60" W X 2.106" PLATE

POWDER COATED STEEL

Pictured in Flat Black

BRISTOL  
 WR



**01700401WR1**  
 6.18" H X 3.9375" PLATE

4" APEX  
 CR, WR



**01704017-1**  
 3.94" H X 3.74" W

APEX VASA  
 AB, CR, SB, PB, WR



**01706018-1**  
 5.9" H X 3.34" PLATE

HAIRPIN  
 GL, GR, WR



**01710610-1**  
 5.125" W x 5.125" D x 6" H



**01710910-1**  
 5.25" W x 5.25" D x 9" H

9" feet are ADA Compliant.

ALUMINUM SLEEVES AND FERRULES

SQUARE METAL FERRULES

BA, CR, SB, WB, WR

Pictured in Brushed Aluminum



**01FRS1010-1**

1" SQ. OUTER DIM.  
x .125" T x 1" H



**01FRS1254-1**

1.25" SQ. OUTER DIM.  
x .125" T x 4" H

ROUND METAL FERRULES

BA, CR, SB, WB, WR

Pictured in Brushed Aluminum



**01FRC1010-1**

.913" OUTER DIAM.  
x .125" T x 1" H



**01FRC1040-1**

.913" OUTER DIAM.  
x .125" T x 4" H

ROUND SLIPPER CUPS

PB



**01SLPR101PB1**

1.576" DIAM. X 1.487"H



**01SLPR102PB1**

1.394" DIAM. X 1.432"H



**01SLPR103PB1**

1.154" DIAM. X 1.522"H

TOE KICK METAL SLEEVES

BA, CR, GL, PB, SB, ST, WB, WR

Pictured in Chrome



**01SLV245-1**

2" SQ. OUTER DIM.  
x .125" T x 4.5" H



**01SLV345-1**

3" SQ. OUTER DIM.  
x .125" T x 4.5" H

SLIPPER CUPS

AB, CR, PB, SB

Pictured in Chrome



**01SLPR107-1**

2.24" SQ. X 1.93"H

\*CR, PB



**01SLPR106-1**

1.59" SQ. X 1.89"H



**01SLPR105-1**

1.26" DIAM. X 2.165"H











**01SLPR104-1**

1.154" DIAM. X 1.87"H



**Available Species**

**Wood Species**

-  **AK:** Red Oak
-  **AL:** Alder
-  **CH:** Cherry
-  **HM:** Hard Maple
-  **HK:** Hickory
-  **PT:** Paint Grade
-  **WK:** White Oak
-  **WL:** Walnut

**Featured:  
Apex Corbel**



EMPIRE BRACKET

CONTOUR BRACKET

SIMPLICITY BRACKET

AK, CH, HM

AK, AL, CH, HM, PT



**01605510-1**

2" W x 7.5" D x 10.973" L

**01600300-1**

2.5" W x 9" D x 9" L

**01607002-1**

2.75" W x 6.375" D x 9.375" L

ARTS & CRAFTS  
BRACKET

COUNTRY BRACKET

BAUHAUS BRACKET

AK, AL, CH, HM, PT, WL

CH, HM

AK, CH, HM, WK, WL

Arch: BA, WR



**01607012-1**

5" W x 7.5" D x 11.5" L

**01600004-1**

1.5" W x 9" D x 6" L

**01600006-1**

2.125" W x 7" D x 9" L

**01600016-1**

2.125" W x 9" D x 12" L

**Metal Finishes**

- BA: Brushed Aluminum
- WR: Flat Black



Featured: 01605008-1 in Walnut

LEXINGTON BAR BRACKET

AK, AL, CH, HM, PT, WK, WL



**01605008-1**  
2.5" W x 10" D x 7.5" L



**01605009-1**  
1.5" W x 10" D x 7.5" L



**01605006-1**  
2.5" W x 10" D x 5" L



**01605007-1**  
1.5" W x 10" D x 5" L

TRIAD CORBEL-NARROW

AK, AL, CH, HM, PT, WK, WL



**01607003-1**

2.875" W x 2.875" D x 12" L



**01607009-1**

2.875" W x 9" D x 12" L



**01607008-1**

2.875" W x 7" D x 9" L

PORTRAIT CORBEL

HM



**01600009-1**

3" W x 8" D x 12" L

TRIAD CORBEL

AK, AL, CH, HM, PT, WK, WL



**01607006-1**

7.5" W x 6" D x 8.375" L



**01607007-1**

3.75" W x 4" D x 5.5" L

PLAIN NOUVEAU CORBEL

AK, AL, CH, HM, PT



**01601400-1**

5.5" W x 9" D x 13" L



**01601300-1**

5.5" W x 2.75" D x 13" L



**01601100-1**

3.5" W x 3.875" D x 6.831" L

APEX CORBEL

AK, CH, HM, WK



**01607317-1**

6" W x 8" D x 14" L



**01607217-1**

3.875" W x 5" D x 8.75" L



**01607117-1**

3" W x 3.875" D x 7" L

SIMPLICITY CORBEL

AK, AL, CH, HM, PT, WK, WL



**01607004-1**

5.5" W x 6.875" D x 7.5" L



**01607001-1**

4.5" W x 5.75" D x 5" L



**01607005-1**

3.5" W x 4.125" D x 4.5" L

REVIVAL CORBEL

AK, AL, CH, HM, PT



**01604510-1**

3.75" W x 9" D x 14" L



**01604505-1**

3.75" W x 9" D x 9" L



**01604500-1**

1.25" W x 5" D x 5" L



OPEN ARTS & CRAFTS CORBEL

CH, HM



**01607013-1**

4.5" W x 7.5" D x 14" L

ARTS & CRAFTS CORBEL

AK, AL, CH, HM, PT, WK, WL



**01607010-1**

4.5" W x 7.5" D x 14" L



**01607011-1**

3.75" W x 5.813" D x 9" L

PLAIN SHAKER CORBEL

AK, AL, HM, PT



**01606005-1**

5" W x 5.313" D x 9" L

SHAKER CORBEL

AK, AL, CH, HM, PT, WK, WL



**01606002-1**

3.875" W x 3.5" D x 6.75" L



**01606001-1**

5.25" W x 6.75" D x 13.25" L



**01606003-1**

6.625" W x 7.5" D x 16" L

CRAFTSMAN CORBEL

AK, AL, CH, HM, PT, WK, WL



**01608001-1**

1.25" W x 1.5" D x 3" L



**01608009-1**

2.75" W x 6" D x 10" L



**01608010-1**

3.5" W x 8" D x 12" L



**01608008-1**

3.5" W x 8" D x 12" L

CRAFTSMAN CORBEL

AK, AL, CH, HM, PT, WK, WL



**01608007-1**

1.5" W x 8" D x 12" L



**01608013-1**

1.25" W x 2.75" D x 18" L



**01608011-1**

7" W x 10" D x 34" L  
 \*AK, AL, CH, HM, PT

MISSION CORBEL

AK, AL, CH, HM, PT, WK, WL



**01601206-1**

2.75" W x 2.625" D x 6" L



**01601205-1**

5.75" W x 3.875" D x 9" L



**01601204-1**

3.5" W x 3.5" D x 13" L



**01601203-1**

3.5" W x 9" D x 13" L

PALLADIAN CORBEL

AK, AL, CH, HM



**01600318-1**

3" W x 3.875" D x 7" L



**01600418-1**

4" W x 5" D x 8.75" L



**01600518-1**

6" W x 8" D x 14" L

PINNACLE CORBEL

CH, HM



**01607316-1**

9" W x 7.25" D x 12" L

**01607216-1**

5.5" W x 5" D x 8" L

HAND CARVED GRAPE CORBEL

CH, HM



**01901005-1**

5.5" W x 7" D x 15" L

**01901003-1**

3.5" W x 8" D x 13" L

MADELINE CORBEL

AK, CH, HM



**01607315-1**

4" W x 9.5" D x 14" L

**01607215-1**

2.5" W x 6.125" D x 8" L

INFINITY CORBEL

AK, CH, HM



**01600937-1**

4.5" W x 5.75" D x 9.5" L

**01600637-1**

3.5" W x 3.875" D x 6.65" L

ACANTHUS CORBELS

CH, HM



**01901105-1**

3.5" W x 8" D x 13" L

**01901001-1**

7.875" W x 6" D x 14.5" L

**01901002-1**

5" W x 4.5" D x 12" L

**01901009-1**

3" W x 1.75" D x 4.5" L  
 SOLD AS A SET OF 2

**01901108-1**

6.5" W x 2.5" D x 15" L

ACANTHUS CORBELS

CH, HM



**01901107-1**

3" W x 1.323" D x 6" L

**01609001-1**

6" W x 4.875" D x 14" L

**01609003-1**

3.5" W x 3.5" D x 10" L

**01609004-1**

3" W x 2" D x 5" L

Gaelic Corbel

CH, HM, WK



**01600928-1**

4.75" W x 5.75" D x 9" L



**01600628-1**

3.5" W x 3.875" D x 6.625" L

Celtic Corbel

CH, HM, WK



**01601427-1**

5.5" W x 7.125" D x 14" L



**01600927-1**

4.75" W x 5.75" D x 9.5" L



**01600627-1**

3.5" W x 3.875" D x 6.625" L



CORINTHIAN CORBEL

CH, HM, PT



**01605002-1**

5.625" W x 6.5" D x 14.5" L



**01605001-1**

4.75" W x 5.5" D x 9.625" L



**01605000-1**

3.875" W x 3" D x 8" L



**01605005-1**

3.5" W x 7" D x 14" L

CORINTHIAN CORBEL

CH, HM, PT



**01904991-1**

3.75" W x 8.5" D x 13" L



**01904990-1**

2.625" W x 2.5" D x 4.5" L



**01901004-1**

5.25" W x 4.5" D x 12.5" L







**01904993-1**

3.75" W x 8.5" D x 13" L



**Available Species**

**Wood Species**

-  **AK:** Red Oak
-  **AL:** Alder
-  **CH:** Cherry
-  **HM:** Hard Maple
-  **HK:** Hickory

**Featured: Plain Half Round Moulding - Series 150**

PLAIN HALF ROUND  
 MOULDING

AK, AL, CH, HM



**SERIES 200**  
**01962010-2**

2" W x 1" T x 96" L

**SERIES 150**  
**01961510-2**

1.5" W x .75" T x 96" L

ROPED HALF  
 ROUND MOULDING

AK, AL, CH, HM, HK



**SERIES 150**  
**01961530-2**

1.5" W x .75" T x 96" L

FLUTED HALF  
 ROUND MOULDING

AK, AL, CH, HM



**SERIES 150**  
**01961540-2**

1.5" W x .75" T x 96" L

**SERIES 200**  
**01962040-2**

2" W x 1" T x 96" L

Series 150 Includes 1.5" Half Round Mouldings and Fits Spaces 2.5" or Wider.  
 Series 200 Includes 2" Half Round Mouldings and Fits Spaces 3" or Wider.

REEDED HALF  
 ROUND MOULDING

AK, AL, CH, HM, HK

AK, AL, CH, HM



**SERIES 150**  
**01961520-2**

1.5" W x .75" T x 96" L



**SERIES 200**  
**01962020-2**

2" W x 1" T x 96" L

PLAIN

AK, AL, CH, HM



**01384210-2**

2.5" W x 1.25" T x 36" H

FLUTED



**01384240-2**

2.5" W x 1.25" T x 36" H

150 COMBO SPINDLE

AK, AL, CH, HM, HK



**SERIES 150**  
**01391510-2**

2" W x .906" D x 9.438" L

CENTER SPINDLES

AK, AL, CH, HM



**SERIES 150**  
**01311510-2**

2.125" W x 1" D x 3" L



**SERIES 200**  
**01312010-2**

2.875" W x 1.41" D x 3.5" L

END BLOCKS

AK, AL, CH, HM



**SERIES 150**  
**01331510-2**

2.5" W x 1.19" D x 5.75" L



**SERIES 200**  
**01332010-2**

3" W x 1.4" D x 5.75" L

END SPINDLES



**SERIES 150**  
**01322010-2**

3" W x 1.4" D x 3.5" L









**SERIES 200**  
**01321510-2**

2.5" W x 1.15" D x 3" L







**Available Species and Finishes**

**Wood Species**

-  **AK:** Red Oak
-  **AL:** Alder
-  **CH:** Cherry
-  **HM:** Hard Maple
-  **HK:** Hickory
-  **PT:** Paint Grade
-  **WK:** White Oak
-  **WL:** Walnut

**Metal Finishes**

-  **GL:** Gold
-  **GR:** Gun Metal Grey
-  **SS:** Stainless Steel
-  **WR:** Flat Black
-  **NA:** Natural Aluminum
-  **WH:** White

**Featured: Natural Aluminum  
Slimline Channel Shelf and  
9" Round Tapered Legs**

Our floating shelves include hidden shelf supports. Hidden shelf supports can be purchased separately for use in your custom projects.

CONTEMPORARY FLOATING CORNER SHELF  
 W/ HIDDEN STEEL SUPPORT

AK, AL, CH, HM, WK, WL, PT

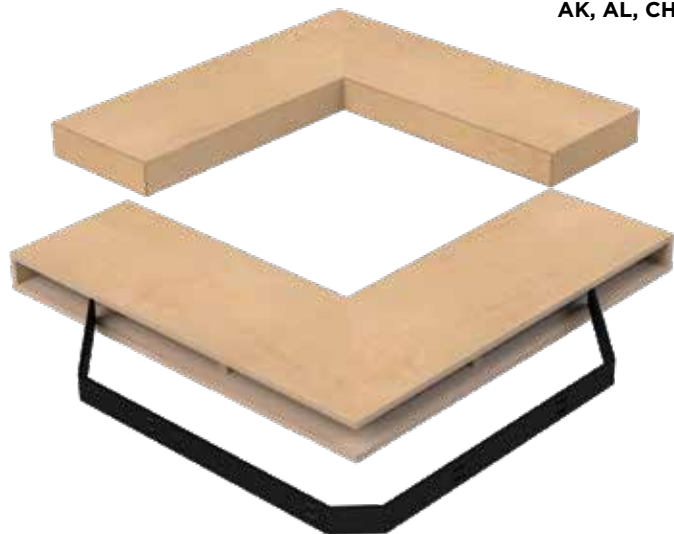

**01MFL103030-1**

10" D x 2.5" T x 30" Each Way



**01MFL102424-1**

10" D x 2.5" T x 24" Each Way

CONTEMPORARY FLAT CORNER SHELF

AK, AL, CH, HM, WK, WL, PT



**01MSH123030-1**

12" D x .75" T x 30" Each Way



**01MSH122424-1**

12" D x .75" T x 24" Each Way

CONTEMPORARY FLOATING LINEAR SHELF W/ HIDDEN STEEL SUPPORT

AK, AL, CH, HM, WK, WL, PT



**01MFL102410-1**

10" D x 2.5" T x 24" L



**01MFL103610-1**

10" D x 2.5" T x 36" L

Custom sizes available!



**TEXTURED**  
 AK, AL, CH, HM, WL



**TEXTURED FLOATING CORNER SHELF  
 W/ HIDDEN STEEL SUPPORT**



**01FL103030-1**

10" D x 2.5" T x 30" Each Way

**TEXTURED FLAT CORNER SHELF**



**01SH123030-1**

12" D x .75" T x 30" Each Way

**TEXTURED FLOATING SHELF  
 W/ HIDDEN STEEL SUPPORT**



**01FL102410-1**

10" D x 2.5" T x 24" W

**TEXTURED FLAT SHELF**



**01SH083610-1**

8" D x .75" T x 36" W



**01SH086010-1**

8" D x .75" T x 60" W



**01SH123610-1**

12" D x .75" T x 36" W



**01FL103610-1**

10" D x 2.5" T x 36" W



**01SH126010-1**

12" D x .75" T x 60" W

## FLOATING SHELF SUPPORT BRACKETS

### 9" HIDDEN SHELF SUPPORT



**01980109WR1**

9.75" W x 8" D x 1.75" H

For use with any floating shelf.

### 16" HIDDEN SHELF SUPPORT



**01980116WR1**

16" W x 8" D x 1.75" H

For use with any floating shelf.

### HIDDEN CORNER SHELF SUPPORT



**01981515WR1**

21.718" W Each Way x 1.65" H

For use with 24" x 24" corner shelf.

### 22.5" HIDDEN SHELF SUPPORT



**01981022WR1**

22.25" W x 8" D x 1.75" H

For use with any floating shelf.



**01982222WR1**

28.75" W Each Way x 1.75" H

For use with 30" x 30" corner shelf.

All Brackets on this page include matching hardware and no marr tabs.

TRUSS BRACKETS - HEAVY DUTY

GR, GL, SS, WR



12" TRUSS BRACKET

**01651260-1**

2" W x 12.5" D x 7.75" L



8" TRUSS BRACKET

**01650860-1**

2" W x 8.5" D x 6" L

MID-CENTURY TRIANGLE BRACKET

GR, GL, SS, WR

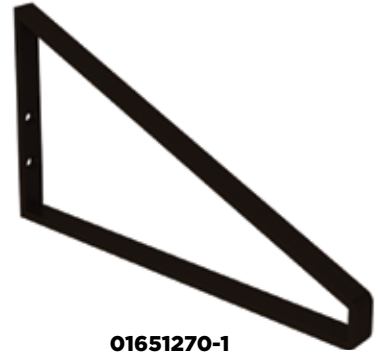

**01651270-1**

.75" W x 12.625" D x 6.875" H

TRUSS STRAPS - HEAVY DUTY

GR, GL, SS, WR

Works with any 3/4" shelf.



12" TRUSS STRAP

**01651250-1**

1" W x 12.75" D x 4.5" L



8" TRUSS STRAP

**01650850-1**

1" W x 8.75" D x 4.5" L

APEX CORNER STRAPS W/ MATCHING LAG BOLTS

Apex Corner Straps work with multiple sized columns, legs, shelves, and corbels. These 2" & 3" straps are an ideal way to add a touch of metal to designs. Each strap comes complete with pyramid head screws in matching finishes.



Pictured: Apex Corner Strap

APEX CORNER STRAPS

GL, GR, WR

Pictured in Flat Black



**01STR200-1**

2" Each Way x .125" T x 1" H



**01STR300-1**

3" Each Way x .125" x 1.5" H

BRASS APEX STRAPS

AB, PB





Pictured in Polished Brass



**01HC1008-1**

2" Each Way x .188" T x 1.5" H

Metal Finishes



-  GL: Gold
-  GR: Gun Metal Grey
-  SS: Stainless Steel
-  WR: Flat Black

SLIMLINE CHANNEL SHELVING



All Slimline Shelving includes heavy duty, flushmount, Contractor Grade French Cleat hanging system. Walldog™ screws and leveler included.

**Metal Finishes**

-  **NA:** Natural Aluminum
-  **WR:** Flat Black
-  **WH:** White

Featuring: Slimline Channel Shelves in Natural Aluminum

SLIMLINE CHANNEL SHELF - ALUMINUM

NA, WH, WR



**01CHSHLF0424-1**

2.5" H x 24" W x 4.125" D

**01CHSHLF0448-1**

2.5" H x 48" W x 4.125" D

**01CHSHLF0436-1**

2.5" H x 36" W x 4.125" D

DEEP SLIMLINE CHANNEL SHELF - ALUMINUM

NA, WH, WR



**01CHSHLF0624-1**

2.5" H x 24" W x 6.125" D

**01CHSHLF0648-1**

2.5" H x 48" W x 6.125" D

**01CHSHLF0636-1**

2.5" H x 36" W x 6.125" D

SLIMLINE CHANNEL SHELF - HARDWOOD



Featuring: Slimline Channel Shelves in Walnut

All Slimline Shelving includes heavy duty, flushmount, Contractor Grade French Cleat hanging system. Walldog™ screws and leveler included.

SLIMLINE CHANNEL SHELF

AK, AL, CH, HM, WK, WL, PT



**01CHSHLF0424-1**

2.75" H x 24" W x 5.125" D

**01CHSHLF0436-1**

2.75" H x 36" W x 5.125" D

**01CHSHLF0448-1**

2.75" H x 48" W x 5.125" D

**01CHSHLF0460-1**



2.75" H x 60" W x 5.125" D

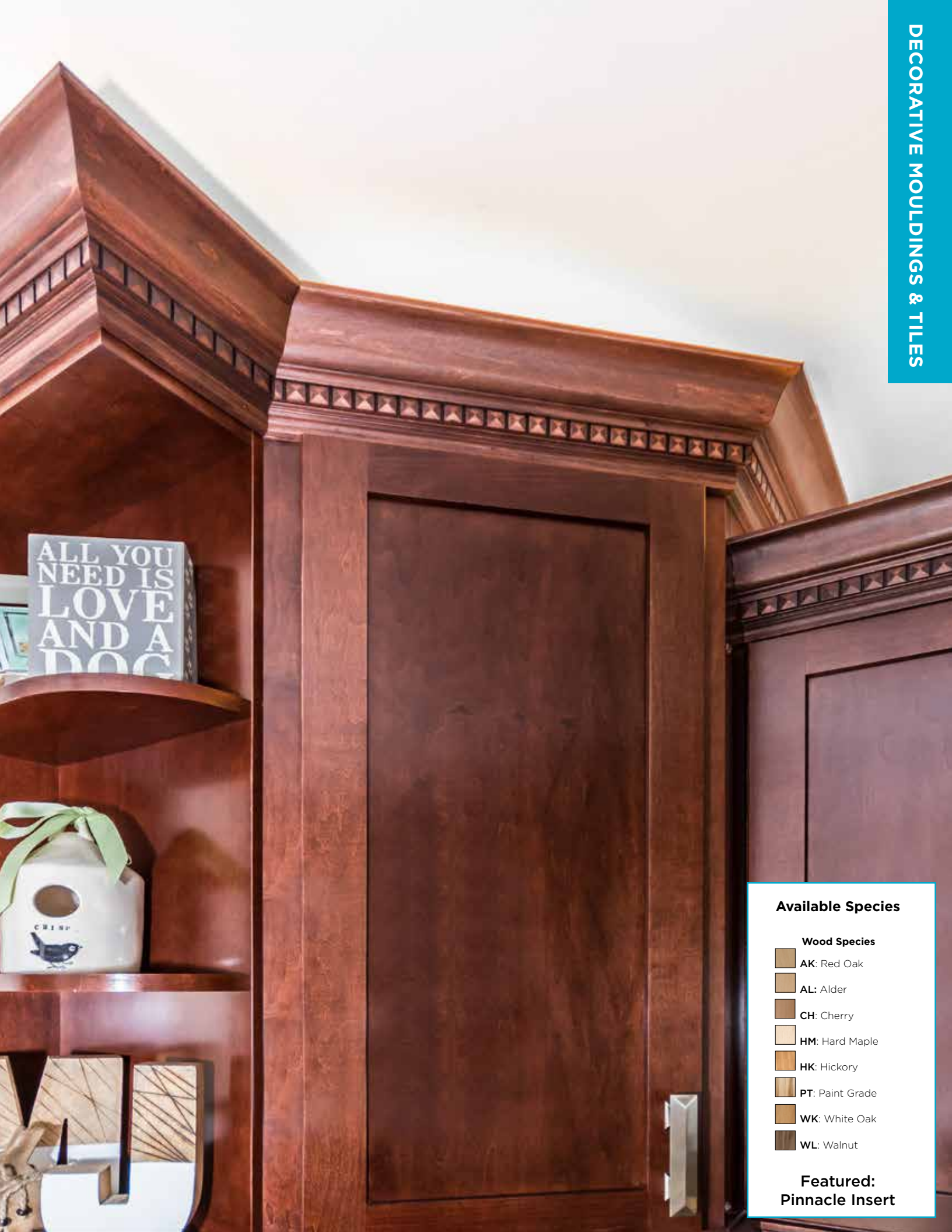



**Available Species**

**Wood Species**

-  **AK:** Red Oak
-  **AL:** Alder
-  **CH:** Cherry
-  **HM:** Hard Maple
-  **HK:** Hickory
-  **PT:** Paint Grade
-  **WK:** White Oak
-  **WL:** Walnut

**Featured:  
Pinnacle Insert**



PANEL MOULDING  
 AK, AL, CH, HM



**01806000-1**  
 3.5" H x .8125" T x 96" L

DECO BASE MOULDING  
 AK, AL, CH, HM



**01827578-1**  
 4.5" H x .75" T x 96" L

HARDWOOD SHIPLAP  
 AK, AL, CH, HM, PT, WK, WL



**01SHIPLAP-1**  
 5.375" W x .375" T x 96" L

CROWN MOULDING  
 AK, AL, CH, HM

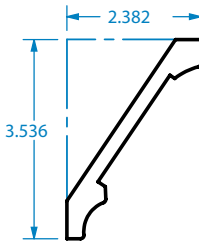

**01807000-1**  
 4.25" H x .625" T x 96" L

TRADITIONAL CROWN MOULDING  
 AK, AL, CH, HM



**01807500-1**  
 5" H x .8125" T x 96" L

REVIVAL CROWN MOULDING  
 AK, AL, CH, HM

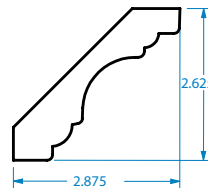

**01807375-1**  
 3.875" H x .84" T x 96" L



Featuring: Slimline Contemporary Light Ready Light Rail<sup>®</sup> Moulding

All mouldings **AK, AL, CH, HM**

SLIMLINE TRADITIONAL  
 LIGHT READY LIGHT RAIL<sup>®</sup> MOULDING



**01860510-1**  
 .625" H x 1.625" T x 96" L

SLIMLINE CONTEMPORARY  
 LIGHT READY LIGHT RAIL<sup>®</sup> MOULDING



**01860520-1**  
 .625" H x 1.625" T x 96" L

TRADITIONAL  
 LIGHT READY LIGHT RAIL<sup>®</sup> MOULDING



**01MB867510-1**  
 1.75" H x 1.625" T x 96" L

CONTEMPORARY  
 LIGHT READY LIGHT RAIL<sup>®</sup> MOULDING



**01MB867520-1**  
 1.75" H x 1.625" T x 96" L

# Designs of distinction®

Kitchen, Bath & Home by BWI

Add custom detail above or below cabinetry, on and around hoods, bathroom vanities, and more. Our inserts can be used on their own as an accent or paired with our mouldings. Inserts fit our 01806000-1, 01807000-1, 01807500-1, 01MB867510-1, and 01MB867520-1. Inserts and mouldings are purchased separately.



Pictured: Infinity Insert in Crown Moulding

### BAROQUE INSERT

CH, HM



**01960745-1**

.72" H x .25" T x 96" L



**01960145-1**

2.2" H x .375" T x 96" L

### INFINITY INSERT

AK, CH, HM



**01960737-1**

.72" H x .28" T x 96" L



**01960137-1**

2.2" H x .75" T x 96" L

### GAELIC INSERT

CH, HM, WK



**01960727-1**

.72" H x .25" T x 96" L



**01960127-1**

2.2" H x .41" T x 96" L

### ACANTHUS INSERT

CH, HM



**01960722-1**

.72" H x .25" T x 96" L



**01960122-1**

2.2" H x .5" T x 96" L

### MISSION INSERT

AK, CH, HM



**01960710-1**

.72" H x .25" T x 96" L



**01960110-1**

2.2" H x .5" T x 96" L



Pictured: Weaved Insert in Panel Moulding

WEAVED INSERT

CH, HM



**01960770-1**

.72" H x .25" T x 96" L



**01960170-1**

2.2" H x .5" T x 96" L

NOUVEAU INSERT

AK, CH, HM



**01960757-1**

.72" H x .25" T x 96" L



**01960157-1**

2.2" H x .5" T x 96" L

CELTIC INSERT

AK, CH, HM



**01960725-1**

.72" H x .25" T x 96" L



**01960125-1**

2.2" H x .5" T x 96" L

PINNACLE INSERT

CH, HM, WK



**01960716-1**

.72" H x .25" T x 96" L



**01960116-1**

2.2" H x .5" T x 96" L

MADELINE INSERT

CH, HM, WK



**01960715-1**

.72" H x .312" T x 96" L



**01960115-1**

2.2" H x .719" T x 96" L

TILES

ACANTHUS LEAF ONLY

CH, HM



**01910123-1**

2.5" W x .5" T x 3" L



**01912523-1**

3.5" W x .75" T x 4.25" L

ACANTHUS SQUARE TILE

CH, HM



**01902023-1**

2.875" SQ. x .5" T

CELTIC TILE

AK, CH, HM



**01902025-1**

2.875" SQ. x .5" T

GAELIC ROSETTE

CH, HM



**01901027-1**

2.75" SQ. x .625" T

LONG PINNACLE TILE

CH, HM



**01901016-1**

5.938" W x .75" T x 2.938" L

MISSION TILE

CH, HM, WK



**01902111-1**

2.875" SQ. x .4375" T

TRIAD TILE

CH, HM, WK



**01901012-1**

2.9375" SQ. x .875" T

INFINITY TILE

AK, CH, HM



**01902538-1**





5.9375" SQ. x 1.375" T





**Available Finishes**

**Metal Finishes**

-  CR: Chrome
-  PB: Polished Brass
-  SB: Satin Brass
-  SS: Stainless Steel
-  WR: Flat Black

**Featured:**  
Polished Brass  
Gallery Rail



Scan for Gallery Rail Sample Kits  
[http://qr.brownwoodinc.com/  
GalleryRailSampleKits](http://qr.brownwoodinc.com/GalleryRailSampleKits)

Attach Gallery Rail components to the tops of cabinets, furniture, shelving, spice racks, and more to create an eye-catching, curated, and luxury look. Typical spacing between posts across the front is approximately 6" - 10" apart. Manufactured from the finest quality cast brass, Gallery Rail components will not tarnish, rust, peel, or chip. Gallery Rail Sample Kits available on our website. See QR code on page 81.

**BRASS GALLERY RAIL**

CR, SB, PB, WR

**CORNER POST**



**01HC9002-1**  
 .906" DIAM. x 1.575" H

**END POST**



**01HC9003-1**  
 .906" DIAM. x 1.575" H

**CENTER POST**



**01HC9001-1**  
 .906" DIAM. x 1.575" H

**ROD**



**01HC900436-1**  
 6 mm DIAM. x 36" L

**CONTEMPORARY GALLERY RAIL**

SS

**END POST**



**01HC9013SS1**  
 .906" DIAM. x 1.575" H  
**Corner Adapter: 01HC8012SS1**  
 1.102" DIAM. X 1.654"H

**CENTER POST**



**01HC9011SS1**  
 .906" DIAM. x 1.575" H

**ROD**



**01HC900436SS1**  
 6 mm DIAM. x 36" L

**APEX CORNER STRAPS W/ MATCHING LAG BOLTS**

Apex Corner Straps work with multiple sized columns, legs, shelves, and corbels. These 2" & 3" straps are an ideal way to add a touch of metal to designs. Each strap comes complete with pyramid head screws in matching finishes.



Pictured: Apex Corner Strap

**APEX CORNER STRAPS**

GL, GR, WR

Pictured in Flat Black



**01STR200-1**  
 2" Each Way x .125" T x 1" H



**01STR300-1**  
 3" Each Way x .125" x 1.5" H

**BRASS APEX STRAPS**

AB, PB









Pictured in Polished Brass



**01HC1008-1**  
 2" Each Way x .188" T x 1.5" H



**Available Species**

-  **AK:** Red Oak
-  **AL:** Alder
-  **CH:** Cherry
-  **HM:** Hard Maple
-  **HK:** Hickory
-  **PT:** Paint Grade
-  **QS:** Qtr Sawn Red Oak
-  **WK:** White Oak
-  **WL:** Walnut

**Featured:**  
Grate Style Toe  
Kick Vent

SINGLE OUTLET



**01450002-1**

3.5" W x .375" T x 5.75" H

DOUBLE OUTLET

AK, AL, CH, HM, HK, QS, WK, WL



**01451002-1**

5.5" W x .375" T x 5.75" H

SINGLE ROCKER



**01450003-1**

3.5" W x .375" T x 5.75" H

DOUBLE ROCKER



**01451003-1**

5.5" W x .375" T x 5.75" H

TRIPLE ROCKER

AK, AL, CH, HM, QS, WK, WL



**01453003-1**

7.313" W x .375" T x 5.75" H

QUAD ROCKER



**01454003-1**

9.125" W x .375" T x 5.75" H

SINGLE SWITCH

AK, AL, CH, HM, QS, WK, WL



**01450001-1**

3.5" W x .375" T x 5.75" H

DOUBLE SWITCH



**01451001-1**

5.5" W x .375" T x 5.75" H

TRIPLE SWITCH

AK, AL, CH, HM, QS, WK, WL



**01453001-1**

7.313" W x .375" T x 5.75" H

QUAD SWITCH



**01454001-1**

9.125" W x .375" T x 5.75" H

SWITCH COMBO 1



**01450012-1**

5.5" W x .375" T x 5.75" H

SWITCH COMBO 2



**01451012-1**

7.313" W x .375" T x 5.75" H

SWITCH COMBO 3



**01450013-1**

5.5" W x .375" T x 5.75" H

SINGLE BLANK  
 SWITCH PLATE COVER



**01452001-1**

3.5" W x .375" T x 5.75" H

DOUBLE BLANK  
 SWITCH PLATE COVER



**01452002-1**

5.5" W x .375" T x 5.75" H

SWITCH COMBO 4



**01451013-1**

7.313" W x .375" T x 5.75" H

ELECTRICAL BOX ROUTING



Let the design of your kitchen island speak for itself. Make one of its most functional yet unsightly components, the electrical outlet, inconspicuous. Integrate electrical outlets into your design and create the perfect union of form and function.

We offer Electrical Box Routing and Electrical Boring to most columns greater than 3"W. Electrical Box Routing allows you to install electrical components directly into the column. For additional electrical wiring, we can bore a ½" hole through the entire length of the column.

AVAILABLE FOR MOST COLUMNS.  
 CALL FOR AVAILABILITY.



Scan for Electrical Box Route Order Form  
[http://qr.brownwoodinc.com/  
 ElectricalRouteForm](http://qr.brownwoodinc.com/ElectricalRouteForm)



GRATE STYLE TOE KICK VENT

AK, AL, CH, HM, WK, WL

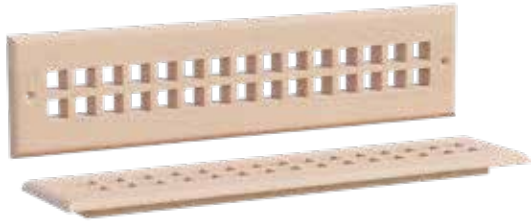

**01992114-1**

15.75" W x .75" T x 3.75" H



**01992110-1**

11.75" W x .75" T x 3.75" H

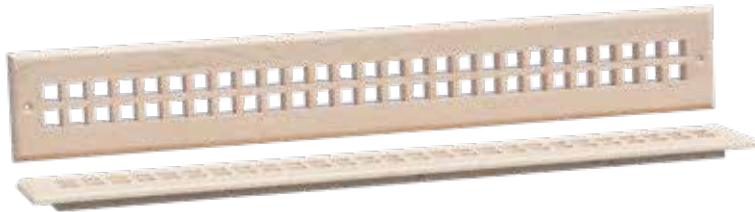

**01992124-1**

25.75" W x .75" T x 3.75" H



**01992112-1**

13.75" W x .75" T x 3.75" H

LINEAR STYLE TOE KICK VENT

AK, AL, CH, HM, WK, WL



**01992214-1**

15.75" W x .75" T x 3.75" H



**01992224-1**

25.75" W x .75" T x 3.75" H



**01992210-1**

11.75" W x .75" T x 3.75" H



**01992212-1**

13.75" W x .75" T x 3.75" H

SELF RIMMING TOE KICK VENT

AK, AL, CH, HM, WK, WL



**01992010-1**  
 11.75" W x .75" T x 3.75" H



**01992012-1**  
 13.75" W x .75" T x 3.75" H



**01992014-1**  
 15.75" W x .75" T x 3.75" H



**01992024-1**  
 25.75" W x .75" T x 3.75" H

SELF RIMMING FLOOR VENT

AK, AL, CH, HM, WK, WL



**01994012-1**  
 13.75" W x .75" T x 5.75" H



**01994010-1**  
 11.75" W x .75" T x 5.75" H

# Designs of distinction®

Kitchen, Bath & Home  
by BWI

Elevate your designs with the sophistication of Brass Bistro Shelving. Flush, Traditional, and Cantilever Bistro Shelving Kits are stocked in Lacquered Polished Brass & Satin Brass, with 8 custom finishes available. To see all Brass Bistro Shelving finishes we offer, order a Brass Sample Kit or visit our website.

## BRASS BISTRO KITS

GLASS SHELVES NOT INCLUDED

Our Brass Bistro Shelving is easy to assemble with set screws and includes installation hardware and assembly instructions.

PB, SB

### CANTILEVER



#### ONLY FOR 10" SHELVES:

##### 3 SHELF

**01CANT1036-1**

36" high, 13" deep

##### 4 SHELF

**01CANT1048-1**

48" high, 13" deep

### FLUSH



#### FOR 10" SHELVES:

##### 3 SHELF

**01FLUSH1036-1**

42" high,  
12.875" deep

##### 4 SHELF

**01FLUSH1048-1**

56.5" high,  
12.875" deep

#### FOR 12" SHELVES:

##### 3 SHELF

**01FLUSH1236-1**

42" high,  
14.875" deep

##### 4 SHELF

**01FLUSH1248-1**

56.5" high,  
14.875" deep

#### FOR 10" SHELVES:

##### 3 SHELF

**01TRAD1036-1**

42.25" high,  
13.375" deep

##### 4 SHELF

**01TRAD1048-1**

56.375" high,  
13.375" deep

#### FOR 12" SHELVES:

##### 3 SHELF

**01TRAD1236-1**

42.25" high,  
15.375" deep

##### 4 SHELF

**01TRAD1248-1**

56.375" high,  
15.375" deep

Wall-to-floor, ceiling-to-countertop, wall-to-countertop... you decide your connection points, number of shelves, and more by designing your custom Bistro Shelving. We offer built-to-order Bistro Shelving in multiple configurations and 8 finishes.

Contact us or send us an order form with your specifications and a quote will be provided.



Scan for Bistro Order Form  
<http://qr.brownwoodinc.com/CustomBrassBistro>

#### Stock Finishes

**PB:** Lacquered Polished Brass

**SB:** Lacquered Satin Brass



Traditional Bistro Shelving in Satin Nickel

**POT RAIL KIT**

All 3 sizes Include 6 matching "S" hooks.

**PB, SB, WR**



**01POTRL1-24-1** 1" Diam. Pot Rail Kit - 24" L



**01POTRL1-30-1** 1" Diam. Pot Rail Kit - 30" L





**01POTRL1-36-1** 1" Diam. Pot Rail Kit - 36" L

**CUSTOM SIZES & FINISHES AVAILABLE**

Brass Bistro Shelving Kits are available in 9 custom finishes and Pot Rail Kits are available in 8 custom finishes.



**Stock Finishes**

-  **PB:** Lacquered Polished Brass
-  **SB:** Lacquered Satin Brass
-  **WR:** Flat Black

Scan for Brass Sample Kits  
<http://qr.brownwoodinc.com/BrassSampleKit>



**Customer Service Contacts:**

Hours: Mon-Fri 8 AM to 5:30 PM CST

Phone: 800-328-5858

Fax: 815-425-8777

Email: [orders@brownwoodinc.com](mailto:orders@brownwoodinc.com)

**Pricing:** All prices are subject to change without notice.

**Terms:** Please contact customer service to set up terms for your account.

**Payment:** Visa, MC, or Amex accepted. Net 30 days (credit must be established). A 3% Credit Card fee will be added starting February 1, 2024.

**Placing an Order:**

Orders can be placed through our shopping cart at [brownwoodinc.com/dod](http://brownwoodinc.com/dod), emailed to [orders@brownwoodinc.com](mailto:orders@brownwoodinc.com), faxed, or phoned in during regular business hours. Orders are typically entered and confirmed within 24 hours of receipt. PLEASE REVIEW YOUR CONFIRMATION FOR ANY ERRORS and advise our customer service team immediately.

**Lead Time:**

Our stock product typically ships within 48 hours. Should there be a back-ordered product, it will be noted on your sales confirmation. Contract/custom product will be shipped based upon the lead time quoted.

**Packaging:**

Designs of Distinction's packaging exceeds common carrier standards. We strive to balance the amount of packaging we use to avoid additional shipping charges while keeping in mind the possibility of freight damage.

**Shipping:**

Shipments are F.O.B. Lincolnwood, IL/Factory.

Orders will ship via UPS/Fed Ex or Truck based on the components size, weight and delivery date requirements. Surcharges may apply due to the size and weight of some items. Freight invoices may be sent separately. If you'd like us to ship on your account, please contact our Customer Service to add your shipping information to your account.

**Damage, Defects or Missing Product:**

All damage and defects, and missing product must be reported within 48 hours of receipt and before finishing. Please provide details and images to our Customer Service.

If you receive a package with apparent outside damage, please reject shipment with the carrier. If damage is not apparent until after package is opened, please contact our Customer Service with details and images.



## Warranty

### Wood, Iron and Metal Components:

- Our liability shall not exceed the replacement cost of our products.
- Defect on the material or workmanship must be reported upon receipt and prior to installation.
- Prompt and proper sealing and finishing is essential to maintain wood stability. Sealing the ends of legs, bun feet and posts, backs and tops of corbels, etc. will reduce the chance of cracking due to moisture loss or moisture increase.
- We do not recommend our stock wood products for exterior use - Doing so will void the warranty.
- **WOOD PRODUCTS MUST BE MAINTAINED UNDER STABLE TEMPERATURE AND HUMIDITY CONDITIONS TO REMAIN UNDER WARRANTY.**
- Defects caused by abuse, negligence, or damage from installation are not covered. Damages arising from improper or incorrect installation are not covered.
- Metal finishes may be subject to small variations. Designs of Distinction<sup>®</sup> is not responsible for color variations and cannot guarantee exact matches between similar items.
- Any product that is proven to be defective in workmanship or material is returned to Designs of Distinction<sup>®</sup> within the applicable warranty period. Designs of Distinction<sup>®</sup> will, at its option, either repair, replace or credit the customer for the purchase price of the product. This warranty extends only to persons or organizations that originally purchase the product from Designs of Distinction<sup>®</sup>.

## Product Information

### Decorative Wire Grille and Mesh:

- Interior applications only. Use of this product on exterior applications will void the warranty.
- Can be cleaned easily with any NON-AMMONIA based cleaners.

### Rattan:

Rattan is a natural product and will vary from sheet to sheet in color. Because our rattan is hand-woven, no two sheets are alike. Rattan will change color as it ages, will fade from the sun, or mold if left in a damp location. Rattan can be cleaned with mild soap and water. Stretching and shrinking of your rattan insert is not considered a defect as this is part of the natural material characteristics.

### Anodized Aluminum:

- **Anodizing Color Range:** Variation in gloss, light & dark, and tristimulus system values (RGB) should be expected. Because anodized coatings are translucent, appearance will vary with viewing angle and base level finish of material.
- **Anodized Aluminum Racking Marks:** All anodized aluminum extrusion and parts must have electrical contact to the part to be anodized. Various contact types are used depending upon the size and geometry of the part being anodized. The electrical contact will leave racking marks on the finished parts. Racking marks include bolt marks, clip marks or thread marks. We strive to minimize the visual impact of racking marks on all of our anodized products but cannot guarantee they will be completely mark free.
- **Exterior Use:** Anodized aluminum parts can be used outdoors but colors may fade overtime. If you are concerned about your color fading, we recommend you do not use this product on an exterior application.

**PART # / PAGE #**

**MATERIALS - TAMBOUR**

011248100-1	9
011248101-1	8
011248102-1	9
011248103-1	8
011248104-1	7
011248105-1	7
011248106-1	7
011248107-1	9
011248110-1	9
011248201-1	8
011248202-1	8
011248203-1	7
011248204-1	7
011248206-1	7
011248207-1	7
011248302-1	10
011248304-1	10
011248402-1	10
011248403-1	10
011296100-1	9
011296101-1	8
011296102-1	9
011296103-1	8
011296104-1	7
011296105-1	7
011296106-1	7
011296107-1	9
011296110-1	9
011296201-1	8
011296202-1	8
011296203-1	7
011296204-1	7
011296206-1	7
011296207-1	7
011296304-1	10
011296402-1	10
011296403-1	10
012446100-1	9
012446102-1	9
012446107-1	9
012446110-1	9
012446304-1	10
012446402-1	10
012446403-1	10

**PART # / PAGE #**

012448100-1	9
012448102-1	9
012448107-1	9
012448110-1	9
012448304-1	10
012448402-1	10
012448403-1	10

**MATERIALS - METAL ACCENT TRIM**

01110030-1	11
01110171-1	11
01110451-1	11
01110451-1	
DripEdge	12
01110788-1	12
01110810-1	12
01HC1000-1	13
01HC1001-1	13
01HC1002-1	13
01HC1003-1	13
01HC1004-1	13
01HC1005-1	13
01HC1006PB1	13
01HC1007PB1	13
01HC1009-1	13
01STRAP7572-1	11
01TP1875-54	13
01TP1875-8	13
01TP50-108	13
01TP50-8	13

**MATERIALS - CUT-TO-SIZE**

0124481802	16
0124481803	16
0124481804	16
0148481802	16
0148481803	16
0148481804	16
01184811614P-1	15
0118481214F-1	14
0118481220T-1	15
011848286S-1	15
011848315C-1	14
011848332P-1	15
011848CG10-1	14

**PART # / PAGE #**

011848DK08-1	15
011848R332PAB1	16
011848R614PAB1	16
011848RE25-1	14
0124481652-1	17
0124482216-1	17
012448MESH-1	17
01247211614P-1	15
0124721214F-1	14
012472286S-1	15
012472332P-1	15
012472DK08-1	15
01362411614P-1	15
0136241214F-1	14
0136241220T-1	15
013624286S-1	15
013624315C-1	14
013624332P-1	15
013624CH10-1	14
013624DK08-1	15
013624R332PAB1	16
013624R614PAB1	16
013624RE25-1	14
01364811614P-1	15
0136481202NT1	16
0136481203NT1	16
0136481204NT1	16
0136481214F-1	14
0136481220T-1	15
013648286S-1	15
013648315C-1	14
013648332P-1	15
013648CG10-1	14
013648DK08-1	15
013648R332PAB1	16
013648R614PAB1	16
013648RE25-1	14
014448MESH-1	17
0148481652-1	17
0148482216-1	17
015936104SS1	17
015936107-1	17
015936112SS1	17
015936116SS1	17
015936118SS1	17

**PART # / PAGE #**

01DGRETAINDER-1	17
<b>POSTS, COLUMNS &amp; TABLE LEGS</b>	
01000110-1	30
01000210-1	30
01000310-1	30
01010280-1	29
01010285-1	29
01020280-1	29
01030210-1	30
01040127-1	32
01040160-1	32
01040210-1	28
01040240-1	28
01040260-1	32
01040270-1	32
01040275-1	32
01042760-1	32
01050210-1	33
01060110-1	33
01060160-1	33
01060210-1	33
01060220-1	33
01060260-1	33
01080210-1	35
01080230-1	35
01080240-1	35
01080270-1	35
01082710-1	35
01082730-1	35
01082740-1	35
01090215-1	36
01100211-1	36
01100218-1	36
01110110-1	32
01110210-1	32
01110218-1	36
01140210-1	37
01150220-1	34
01160210-1	34
01160310-1	34
01180210-1	20
01180240-1	20
01210110-1	30
01210210-1	30

PART # / PAGE #	PART # / PAGE #	PART # / PAGE #	PART # / PAGE #
01220160-1 32	01550240-1 20	01632010-1 26	<b>BUN FEET</b>
01220260-1 32	01560210-1 34	01633010-1 26	01240006-1 49
01230210-1 35	01560222-1 37	01634010-1 26	01240009-1 49
01230230-1 35	01570217-1 37	01635010-1 26	01241006-1 49
01230240-1 35	01570317-1 37	01636010-1 26	01241009-1 49
01230270-1 35	01580217-1 37	01722010-1 22	01242006-1 49
01240210-1 36	01580317-1 37	01722910-1 21	01242009-1 49
01240310-1 36	01590122-1 31	01723001-1 23	01243006-1 44
01250210-1 20	01590123-1 31	01723010-1 23	01243009-1 44
01250310-1 20	01590124-1 31	01724001-1 24	01244006-1 44
01270110-1 27	01590125-1 31	01724010-1 24	01244009-1 44
01270110-3 27	01590127-1 31	01724500-1 22	01245106-1 44
01270210-1 27	01590128-1 31	01724529-1 21	01245109-1 44
01270210-3 27	01590210-1 34	01725001-1 25	01700011-1 48
01280110-1 27	01590222-1 31	01725010-1 25	01700012CR1 50
01280110-3 27	01590223-1 31	01732010-1 26	01700015-1 48
01280210-1 27	01590224-1 31	01733010-1 26	01700018-1 47
01280210-3 27	01590225-1 31	01734010-1 26	01700146-1 45
01290180-1 29	01590227-1 31	01734510-1 23	01700210-1 46
01290280-1 29	01590228-1 31	01735010-1 26	01700245-1 49
01310110-1 28	01606010-1 25		01700310-1 46
01310110-3 28	01610210-1 34	<b>END PANELS</b>	01700327-1 45
01310210-1 28	01612010-1 21	<b>&amp; METAL BASES</b>	01700345-1 49
01310210-3 28	01612010-3 21	01XBS2824WR1 41	01700400CR1 50
01370210-1 30	01613010-1 23	01XBS3424WR1 41	01700401-1 50
01410110-1 33	01613025-1 23	01XBS3436WR1 41	01700402CR1 50
01410210-1 33	01614010-1 24	01XCONT2824SS1 41	01700406-1 50
01470110-1 30	01614025-1 24	01XCONT2824WR1 41	01700408-1 50
01470210-1 30	01615010-1 25	01XPN1525LNG-1 39	01700410-1 50
01510110-1 33	01621025-1 21	01XPN1525LNG-4 40	01700412-1 50
01510200-1 34	01621025-3 21	01XPN1536LNG-1 39	01700427-1 45
01510202-1 34	01621729-1 23	01XPN1536LNG-4 40	01700457-1 45
01510203-1 29	01622010-1 22	01XPN3025LNG-1 39	01700627-1 45
01510204-1 36	01622010-3 22	01XPN3025LNG-4 40	01700905CR1 50
01510210-1 33	01622025-1 22	01XPN3036LNG-1 39	01702022-1 44
01510228-1 20	01622025-3 22	01XPN3036LNG-4 40	01702510-1 48
01510328-1 20	01623010-1 23	01XPNL1525-1 39	01703010-1 43
01515028-1 20	01623017-1 23	01XPNL1525-4 40	01703110-1 43
01520210-1 34	01623025-1 23	01XPNL1536-1 39	01703210-1 43
01520223-1 37	01624010-1 24	01XPNL1536-4 40	01703310-1 43
01530210-1 28	01624025-1 24	01XPNL3025-1 39	01703510-1 46
01530310-1 28	01625010-1 25	01XPNL3025-4 40	01704010-1 48
01540210-1 28	01625046-1 36	01XPNL3036-1 39	01704017-1 50
01540310-1 28	01626010-1 25	01XPNL3036-4 40	01704040-1 48
01550210-1 20	01626050-1 36		01704060-1 45

**PART # / PAGE #**

01704075-1	46
01704110-1	48
01704210-1	48
01704245-1	49
01704535-1	48
01704910-1	48
01705080-1	45
01705110-1	46
01705112-1	46
01705150-1	46
01705155-1	47
01705175-1	46
01705225-1	47
01705310-1	48
01705510-1	46
01705515-1	47
01705610-1	46
01705710-1	45
01705715-1	46
01705810-1	46
01706005-1	48
01706010-1	48
01706018-1	50
01706035-1	48
01706060-1	47
01706061-1	47
01706065-1	45
01707410-1	44
01707440-1	44
01707610-1	44
01707710-1	44
01708010-1	43
01708110-1	43
01708310-1	43
01709010-1	44
01709035-1	48
01710610-1	50
01710910-1	50
01721010-1	49
01731010-1	49
01742060-1	45
01750460-1	45
01760410-1	48
01FRC1010-1	51
01FRC1040-1	51

**PART # / PAGE #**

01FRS1010-1	51
01FRS1254-1	51
01SLPR101-1	51
01SLPR103-1	51
01SLPR104-1	51
01SLPR105-1	51
01SLPR106-1	51
01SLPR107-1	51
01SLV2-1	49
01SLV245-1	51
01SLV3-1	49
01SLV345-1	51
01SLV4-1	49
01SLV5-1	49
<b>BRACKETS &amp; CORBELS</b>	
01600004-1	53
01600006-1	53
01600009-1	55
01600016-1	53
01600300-1	53
01600318-1	60
01600418-1	60
01600518-1	60
01600627-1	63
01600628-1	63
01600637-1	61
01600927-1	63
01600928-1	63
01600937-1	61
01601100-1	56
01601203-1	60
01601204-1	60
01601205-1	60
01601206-1	60
01601300-1	56
01601400-1	56
01601427-1	63
01601450-1	55
01604500-1	57
01604505-1	57
01604510-1	57
01605000-1	64
01605001-1	64
01605002-1	64

**PART # / PAGE #**

01605005-1	64
01605006-1	54
01605007-1	54
01605008-1	54
01605009-1	54
01605510-1	53
01606001-1	58
01606002-1	58
01606003-1	58
01606005-1	58
01607001-1	57
01607002-1	53
01607003-1	55
01607004-1	57
01607005-1	57
01607006-1	55
01607007-1	55
01607008-1	55
01607009-1	55
01607010-1	58
01607011-1	58
01607012-1	53
01607013-1	58
01607117-1	56
01607215-1	61
01607216-1	61
01607217-1	56
01607315-1	61
01607316-1	61
01607317-1	56
01608001-1	59
01608007-1	59
01608008-1	59
01608009-1	59
01608010-1	59
01608011-1	59
01608013-1	59
01609001-1	62
01609003-1	62
01609004-1	62
01901001-1	62
01901002-1	62
01901003-1	61
01901004-1	64
01901005-1	61

**PART # / PAGE #**

01901009-1	62
01901105-1	62
01901107-1	62
01901108-1	62
01904990-1	64
01904991-1	64
01904993-1	64
<b>CREATE-A-COLUMN</b>	
01311510-2	67
01312010-2	67
01321510-2	67
01322010-2	67
01331510-2	67
01332010-2	67
01384210-2	66
01384240-2	66
01391510-2	67
01961510-2	66
01961520-2	66
01961530-2	66
01961540-2	66
01962010-2	66
01962020-2	66
01962040-2	66
<b>SHELVING</b>	
01650850-1	72
01650860-1	72
01651250-1	72
01651260-1	72
01651270-1	72
01980109WR1	71
01980116WR1	71
01981022WR1	71
01981515WR1	71
01982222WR1	71
01CHSHLF0424-1	73
01CHSHLF0424-1 (METAL)	73
01CHSHLF0424-1 (WOOD)	74
01CHSHLF0436-1 (METAL)	73
01CHSHLF0436-1 (WOOD)	74

**PART # / PAGE #**

01CHSHLF0448-1	
(METAL)	73
01CHSHLF0448-1	
(WOOD)	74
01CHSHLF0460-1	
(METAL)	73
01CHSHLF0460-1	
(WOOD)	74
01CHSHLF0624-1	73
01CHSHLF0636-1	73
01CHSHLF0648-1	73
01CHSHLF0660-1	73
01FL102410-1	70
01FL103030-1	70
01FL103610-1	70
01HC1008-1	72, 82
01MFL102410-1	69
01MFL102424-1	69
01MFL103030-1	69
01MFL103610-1	69
01MFL104810-1	69
01MSH122424-1	69
01MSH123030-1	69
01SH083610-1	70
01SH086010-1	70
01SH123030-1	70
01SH123610-1	70
01SH126010-1	70
01STR200-1	72, 82
01STR300-1	72, 82

**MOULDINGS & TILES**

01806000-1	76
01807000-1	76
01807375-1	76
01807500-1	76
01827578-1	76
01860510-1	77
01860520-1	77
01901012-1	80
01901016-1	80
01901027-1	80
01902023-1	80
01902025-1	80
01902111-1	80
01902538-1	80

**PART # / PAGE #**

01910123-1	80
01912523-1	80
01960110-1	78
01960115-1	79
01960116-1	79
01960122-1	78
01960125-1	79
01960127-1	78
01960137-1	78
01960145-1	78
01960157-1	79
01960170-1	79
01960710-1	78
01960715-1	79
01960716-1	79
01960722-1	78
01960725-1	79
01960727-1	78
01960737-1	78
01960745-1	78
01960757-1	79
01960770-1	79
01MB867510-1	77
01MB867520-1	77
01SHIPLAP-1	76

**FINISHING TOUCHES & HARDWARE COMPONENTS**

01HC9002-1	82
01HC9003-1	82
01HC9001-1	82
01HC900436-1	82
01HC9013SS1	82
01HC8012SS1	82
01HC9011SS1	82
01STR200-1	72, 82
01STR300-1	72, 82
01HC1008-1	72, 82

**FINISHING TOUCHES:  
OUTLET COVERS  
& FLOOR VENTS**

01450001-1	84
01450002-1	84
01450003-1	84
01450012-1	85
01450013-1	85

**PART # / PAGE #**

01451001-1	84
01451002-1	84
01451003-1	84
01451012-1	85
01451013-1	85
01452001-1	85
01452002-1	85
01453001-1	84
01453003-1	84
01454001-1	84
01454003-1	84
01992010-1	87
01992012-1	87
01992014-1	87
01992110-1	86
01992112-1	86
01992114-1	86
01992124-1	86
01992210-1	86
01992212-1	86
01992214-1	86
01992224-1	86
01994010-1	87
01994012-1	87

**BISTRO SHELVING**

01CANT1036-1	88
01CANT1048-1	88
01FLUSH1036-1	88
01FLUSH1048-1	88
01FLUSH1236-1	88
01FLUSH1248-1	88
01TRAD1036 -1	88
01TRAD1048-1	88
01TRAD1236-1	88
01TRAD1248-1	88
01POTRL1-24-1	89
01POTRL1-30-1	89
01POTRL1-36-1	89





*Designs of distinction*<sup>®</sup>  
Kitchen, Bath & Home by BWI

  @designsofdistinction\_kbh

[www.brownwoodinc.com](http://www.brownwoodinc.com) | 800-328-5858 | [info@brownwoodinc.com](mailto:info@brownwoodinc.com)

