

BAR SIZE
IS .375 X .5

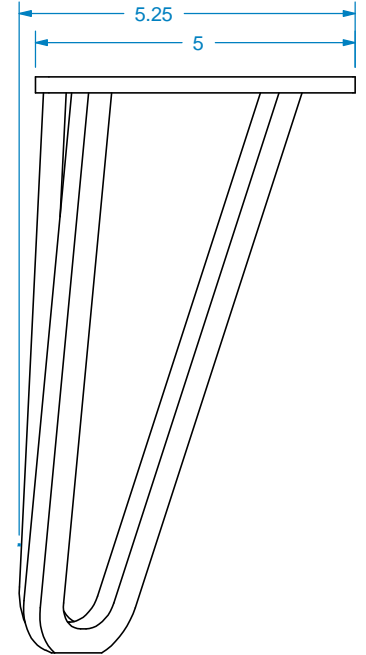
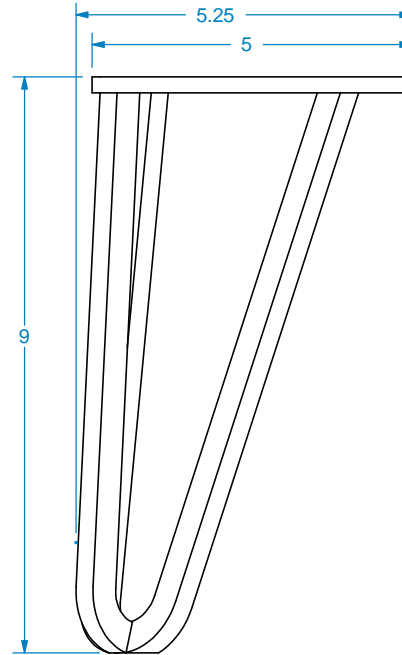
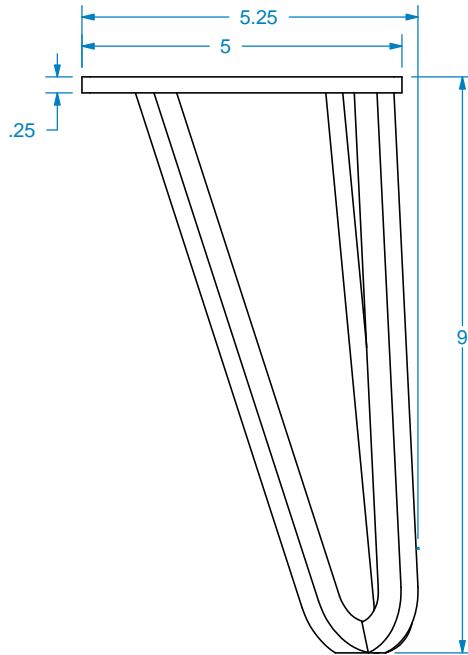
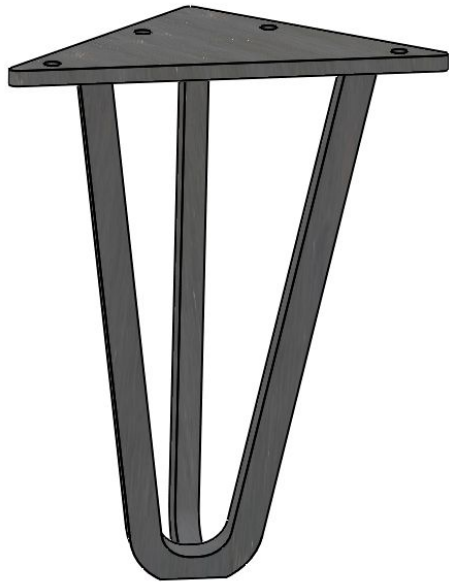
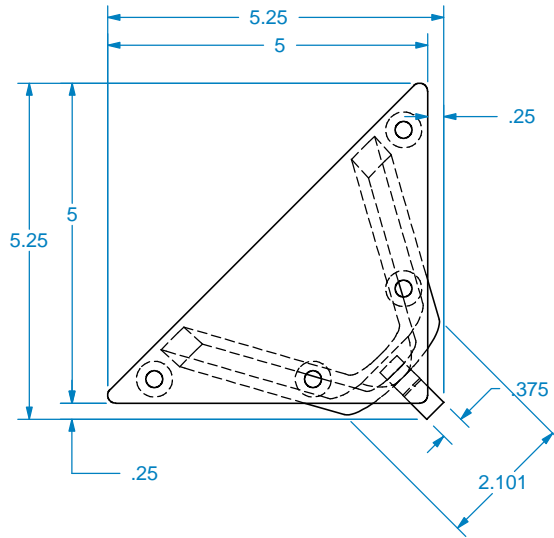

Designs of
distinction
by Brown Wood, Inc.
est. 1998

REVISION HISTORY		
REV	REV DATE	DESCRIPTION

TOLERANCES	
WIDTH	± .03125"
THICKNESS	± .03125"
LENGTH	± .0625"
ANGULAR	± x.x°
PROFILE	± x.xxx"
Use General Tolerances Unless Noted	

MATERIALS AND FINISHES	
PLEASE VISIT OUR WEBSITE FOR A COMPLETE LIST. www.brownwoodinc.com 1-800-328-5858	
NOTES:	
Do not scale. Use dimensions only. All dimensions are in inches unless noted	

TITLE:	9" HAIRPIN LEG	
	NOMINAL SIZE 5.25" X 5.25" X 9"	
DWG #:	01710910-1	REV:
DATE:	2/4/2019	SCALE:
		1:3