

QUICK REFERENCE FOR LARGE BUNGALOW BRACKETS

PLAIN
01601410-1

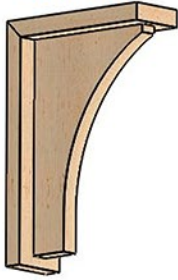

ABBEY
01641411-1

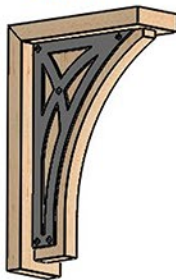

BASILICA
01641412-1



TUDOR
01641413-1

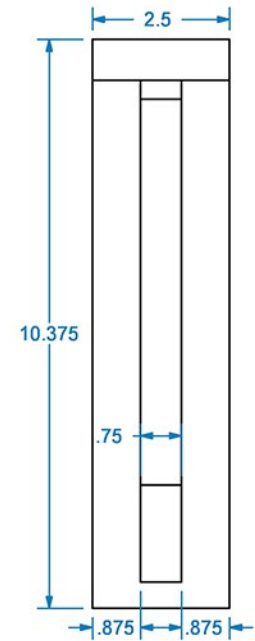
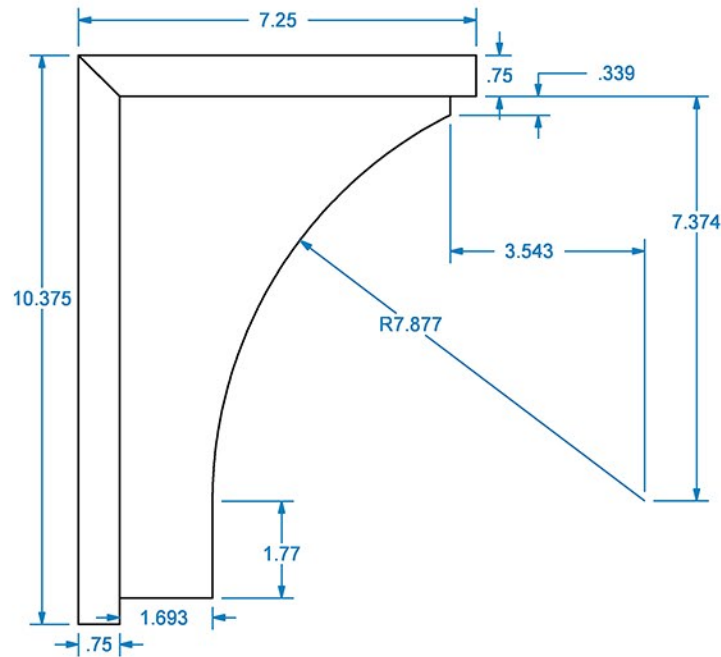
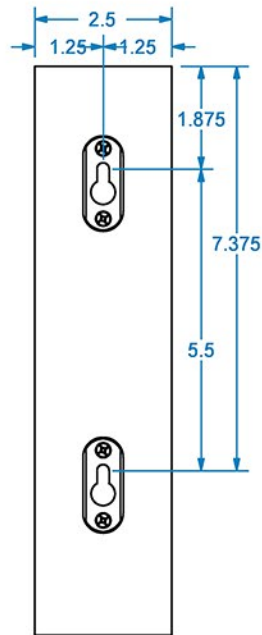
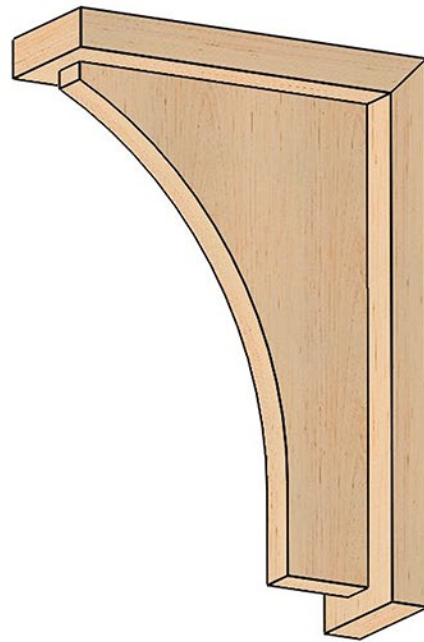
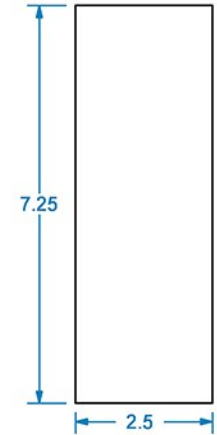
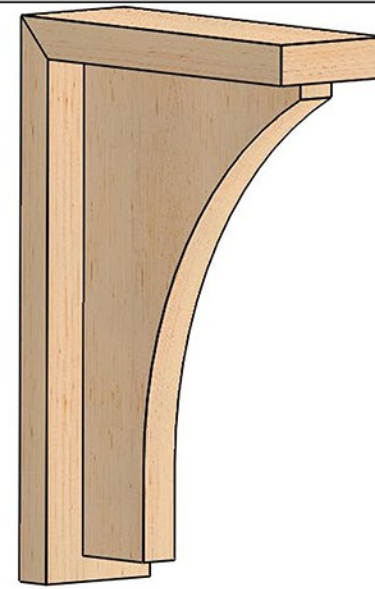
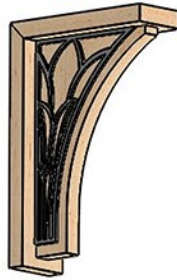

Designs of distinction
by Brown Wood, Inc.
est. 1998

REVISION HISTORY		
REV	REV DATE	DESCRIPTION
A	11/06/2015	UPDATED TO MATCH CATLOG INFORMATION

TOLERANCES	
WIDTH	± .03125"
THICKNESS	± .03125"
LENGTH	± .0625"
ANGULAR	± x.x°
PROFILE	± x.xxx"
Use General Tolerances Unless Noted	

MATERIALS AND FINISHES	
PLEASE VISIT OUR WEBSITE FOR A COMPLETE LIST. www.brownwoodinc.com 1-800-328-5858	
NOTES: ADDITIONAL SPECIES AVAILABLE	
Do not scale. Use dimensions only. All dimensions are in inches unless noted	

TITLE: LARGE BUNGALOW BRACKET	
NOMINAL SIZE 2.5" X 7.25" X 10.375"	
DWG #: 01601410-1	REV: A
DATE: 10/14/2017	SCALE: 1:3.5